

1-1-2021

## A topological overview of microgrids: from maturity to the future

AYŞE KÜBRA ERENOĞLU

SEMANUR SANCAR

OZAN ERDİNÇ

MUSTAFA BAĞRIYANIK

Follow this and additional works at: <https://journals.tubitak.gov.tr/elektrik>



Part of the [Computer Engineering Commons](#), [Computer Sciences Commons](#), and the [Electrical and Computer Engineering Commons](#)

---

### Recommended Citation

ERENOĞLU, AYŞE KÜBRA; SANCAR, SEMANUR; ERDİNÇ, OZAN; and BAĞRIYANIK, MUSTAFA (2021) "A topological overview of microgrids: from maturity to the future," *Turkish Journal of Electrical Engineering and Computer Sciences*: Vol. 29: No. 3, Article 2. <https://doi.org/10.3906/elk-2012-80>  
Available at: <https://journals.tubitak.gov.tr/elektrik/vol29/iss3/2>

This Article is brought to you for free and open access by TÜBİTAK Academic Journals. It has been accepted for inclusion in Turkish Journal of Electrical Engineering and Computer Sciences by an authorized editor of TÜBİTAK Academic Journals. For more information, please contact [academic.publications@tubitak.gov.tr](mailto:academic.publications@tubitak.gov.tr).

## A topological overview of microgrids: from maturity to the future

Ayşe Kübra ERENOĞLU<sup>1</sup> , Semanur SANCAR<sup>2,\*</sup> , Ozan ERDİNÇ<sup>1</sup> ,  
Mustafa BAĞRIYANIK<sup>3</sup> 

<sup>1</sup>Department of Electrical Engineering, Faculty of Electrical & Electronics,  
Yıldız Technical University, İstanbul, Turkey

<sup>2</sup>Department of Electrical & Electronics Engineering, Faculty of Engineering,  
Özyeğin University, İstanbul, Turkey

<sup>3</sup>Department of Electrical Engineering, Faculty of Electrical & Electronics,  
İstanbul Technical University, İstanbul, Turkey

Received: 16.12.2020

Accepted/Published Online: 07.05.2021

Final Version: 31.05.2021

**Abstract:** The concept of microgrid (MG) has attracted great attention from the system operators for increasing operational effectiveness as well as providing more reliable, sustainable and economic power system. In this paper, a comprehensive investigation is presented to shine new light on evaluating changes in MG operation from maturity to the future. A great deal of literature studies consisting of the traditional MG architecture, encountered challenges and proposed solutions for overcoming them are all examined in detail. Also, the impact of highly integrated renewable-based energy sources into the power system is analysed by current studies. Moreover, modern MG architecture is extensively investigated from the point of operational flexibility such as energy storage systems (ESSs), combined structure of networked-MGs (NMGs) and demand-side management (DSM). Furthermore, incorporating MG architecture as a grid-support service in power system resiliency enhancement strategies is investigated with current literature studies. As a result of this detail investigation, it can be deduced that the power system has witnessed radically new changes and outstanding developments in both generation and consumption side. Renewable power sources have been accepted as the major mile stone in the harnessing electricity and there have a strong trend towards penetrating these types of generation units in MG structure. On the other hand, increased concerns about safety problems and challenges in MG have triggered a huge amount of discussions in the literature.

**Key words:** Demand-side management, energy storage systems, networked microgrid structure, operational flexibility, power system resiliency

Nomenclature / Abbreviations			
ADP	Adaptive dynamic programming	MILP	Mixed integer linear programming
BESS	Battery energy storage	MMG	Multimicrogrid
CHP	Combined heat and power	MPPT	Maximum power point tracking
DAB	Dual active bridge	NILM	Nonintrusive load monitoring
DER	Distributed energy resource	NMG	Networked microgrid
DG	Distributed generation	PAR	Peak-to-average ratio
DSM	Demand-side management	PBDR	Price-based demand response program
DSO	Distribution system operator	PCC	Point of common coupling
EMS	Energy management system	PE	Power electronic
ESS	Energy storage system	PI	Proportional integral
EV	Electrical vehicle	PSO	Partical swarm optimization
IoT	Internet of things	PV	Photovoltaic
MG	Microgrid	RES	Renewable energy source

\*Correspondence: [semanur.sancar@ozu.edu.tr](mailto:semanur.sancar@ozu.edu.tr)

## 1. Introduction

### 1.1. Motivation and background

Microgrids (MGs) are small and local distribution grids that offer flexibility for power system operators within the scope of the smart grid concept. Thanks to their ability to operate in islanded or grid-connected modes, MGs provide an advantageous framework for both utility and consumers in terms of increasing reliability and efficiency. It is necessary here to clarify that this concept dates back to 1882 when Thomas Edison installed the first power plant in the United States which was the major milestone of the locally controllable decentralized entity [1].

One of the most widely-known institutions/corporations have provided definitions for MG in the literature as follows. Among them U.S. Department of Energy defined MG as “*A microgrid is a group of interconnected loads and distributed energy resources within clearly defined electrical boundaries that acts as a single controllable entity with respect to the grid. A microgrid can connect and disconnect from the grid to enable it to operate in both grid-connected or island-mode*” [2]. A conceptual definition of MG by CIGRÉ C6.22 Working Group’s viewpoint is as follows: “*Microgrids are electricity distribution systems containing loads and distributed energy resources, (such as distributed generators, storage devices, or controllable loads) that can be operated in a controlled, coordinated way either while connected to the main power network or while islanded*” [3].

One of the main reasons for development of the MG concept is the penetration of renewable energy sources (RESs). Therefore, the fundamental elements of MGs are distributed energy resources (DERs), loads and controllers. However, utilizing RESs-based units in the power supply side instead of fossil resources can surely cause many drawbacks such as control, dynamic and energy management problems from the system operator’s perspective. These types of resources are completely weather dependent, in other words, intermittent and highly volatile nature can potentially cause uncertainties in MG which is critical subject to be investigated. Various statistical tools such as machine learning tools and probability distribution functions are widely used to forecast energy availability in this structure for capturing the stochasticity in the generation side. On the other hand, due to emerging the concept of “prosumers”, load forecasting in utilization end in MG becomes crucial challenge as well. Demand response implementations and changing behaviours of end-users introduce the other type of uncertainty in the operation of MGs. Therefore, matching supply and demand is essential concern which should be provided at every instant operating time [4]. The control and management systems play a vital role, with benefits and challenges, for these various units to work in a coordinated, integrated and efficient manner [5].

Herein, thanks to the point of common coupling (PCC), the ability to operate in islanded mode and grid-connected mode provides enhanced flexibility in the management of MGs. In cases where local resources are insufficient, grid connection is used to meet the demands of end users and supply-demand imbalances can be avoided. This flexibility also makes it possible to regulate voltage and frequency stability problems. On the other hand, MGs can continue to operate independently by switching from the grid to increase resiliency and reliability when major outages occur or to increase the deployment of RESs-based energy sources [6]. However, in islanded mode of operation, distributed resources should supply the local loads for maintaining proper voltage and frequency stability. Also, stationary DERs have to handle inrush currents from large loads while transitioning from grid-parallel to islanded mode after switching actions [7]. Unless the main grid and islanded portions are in synchronism, it is certainly to be avoided for closing switches. When all these operational issues are considered, the master controllers are expected to keep active and reactive powers in balance at all periods, as well as to ensure optimal dispatch of local resources with the help of control, automation and communication systems [1].

## 1.2. Overview of the existing review oriented literature

In recent years, there has been an increasing amount of literature dedicated to the detailed overview of MG's system structure, control/coordination approaches, protection schemes, and energy management strategies in order to proposed MG in reliable and optimal fashion. Among them, Guerrero et al. [8] provided an overview of advanced distributed, hierarchical, and decentralized control methods for grid-connected and islanded MGs. Olivares et al. [9] focused on reviewing the studies based on the state-of-the-art control methodologies encountered major challenges by virtue of integrating volatile RESs into MGs. To point out the power quality issues on MG operation, Guerrero performed a survey on covering control schemes, penetration of distributed-energy-storage systems and AC/DC hybrid MGs [10]. Bidram and Davoudi [11] systematically reviewed the relevant literature on advanced hierarchical control strategies classifying them as a primary, secondary, and tertiary control. Dragicevic et al. [12] presented an extensive review of control methods categorizing them as decentralized, centralized, and distributed depend on the communication method as well as stabilization techniques for DC MGs.

In addition to, fundamental design features of existing MGs as well as basic control functions for ensuring reliable, economic and safe operation of MGs in various operating modes and transitions were all summarized in [13]. This study intended to provide a range of recommendations and general guidelines that may be useful for designers and researchers dealing with real MGs' challenges.

In [14], power sharing control principles was comprehensively reviewed and compared with various control frameworks. Also, pros and cons of them were highlighted in the study for islanded AC MGs implementations. Reference [15] investigated the distributed control and management methods especially for the next generation power system in the context of smart grid paradigm. Majumder [16] attempted to investigate the stability issue from different aspects (e.g., small signal, transient and the voltage stability) with conducting a brief review encapsulating the existing control methods in the literature. Colson and Nehrir [17] briefly discussed the existing MG technologies, the possible challenges due to the DER integration. Also, a multiagent based control framework to operate related MG in an optimal, robust and reliable fashion was proposed. Reference [18] carried out a review study on the specific subject on table-based direct power control scheme, evaluating its performance from the point of the voltage and frequency stability. Furthermore, the study presented in [19] covered general MG architectures, developed control methodologies, models and layouts.

On the other perspective, Chaudhary et al. [20] investigated the protection system challenges when DG integration become inevitable for MGs. In addition, developed several protection frameworks which basically used the fault voltages were examined in detail. The authors in [21] critically reviewed the existing approaches of adaptive protection framework as well as providing information about possible technical challenges caused by using traditional methods.

Ettxeberria et al. [22] analysed the opportunities and topologies of energy storage systems (ESSs) which present a good solution in terms of facilitating RESs incorporation into the MG structure. Similarly, the technical review study presented in [23] concentrated on the role of MG in case of highly penetrated electric vehicles (EVs) and ESSs to the grid. Besides, control and operation of networked MGs (NMGs) were detailed in the study.

The study in [24] described some of the more recent developments in MG structure which aims to investigate the multiagent based system approach from different aspects such as market modeling, power restoration, control and optimization.

Review of different energy management systems (EMSs) and improved power management strategies were presented in [25] and [26] from different aspects, respectively. Another general review on demand response strategies and required infrastructure, control and communication protocols was carried out by Samad et al. [27].

Furthermore, Barnes et al. [28] presented a concise review of the real-world implementation and demonstration projects of MG concept. Dragicevic et al. [29] provided a review study for current hardware topologies and their famous application areas including DC households, EV charging stations, RES parks, and hybrid ESSs.

Hirsch et al. [30] analyzed real-life implementations and challenges in today’s MGs with also shedding light on the future. The authors in [31] reviewed the existing and simulated MGs also different distribution systems within the scope of reliability, efficiency and power quality issues. Also in [32], an informative preliminary analysis was created for site screening and feasibility studies. The study provided an overview of the available financial mechanisms for MGs. Furthermore, conducted literature studies about designing and implementing of MGs were detailed in [33] for readers. A taxonomy table (Table 1) has been provided for the purpose of presenting motivation behind this study more clearly. It enables to figure out the gaps of the existing studies and contributions of this study to the literature.

**Table 1.** Categorization of review studies in MG from different perspectives.

Authors/year	Ref.	RES	ESS	PE	DSM	NMG	Control strategies	Energy management basis	Resiliency
Parhizi et al. (2015)	[1]	✓	✓	✓	✓	✓	✓		✓
Mohammed et al. (2019)	[5]	✓	✓				✓	✓	
Anderson and Suryanarayanan (2020)	[6]	✓	✓		✓				
Dragicevic et al. (2015)	[12]	✓	✓	✓			✓		
Han et al. (2016)	[14]	✓					✓		
Colson and Nehrir (2009)	[17]	✓	✓				✓	✓	
Alonso-Martinez et al. (2010)	[18]			✓			✓		
Mahmoud et al. (2015)	[19]	✓	✓	✓		✓	✓	✓	
Choudhary et al. (2014)	[20]	✓	✓				✓		
Habib et al. (2017)	[21]		✓						
Etxeberria et al. (2010)	[22]	✓	✓					✓	
Ravichandran et al. (2013)	[23]		✓			✓		✓	
Kulasekera et al. (2011)	[24]		✓				✓		
Mostafa et al. (2014)	[25]				✓		✓	✓	
Nanfang Yang et al. (2013)	[26]		✓				✓	✓	
Dragicevic et al. (2016)	[29]	✓	✓	✓		✓	✓		
Bist et al. (2020)	[34]	✓	✓					✓	
Meng et al. (2017)	[35]		✓	✓		✓	✓	✓	
Faisal et al. (2018)	[36]	✓	✓	✓				✓	
Arani et al. (2019)	[37]		✓	✓			✓		
Mwasilu et al. (2014)	[38]	✓	✓	✓			✓	✓	
Yong et al. (2015)	[39]	✓		✓	✓		✓	✓	
Nosratabadi et al. (2017)	[40]	✓	✓		✓		✓	✓	
This paper		✓	✓	✓	✓	✓	✓	✓	✓

### 1.3. Content and contributions

The main aim of this comprehensive investigation is to shine new light on evaluating changes in MG operation from past to future. The key operational issues such as traditional control/coordination and power management schemes, the increasing integration of RES-based DG units and the applications of power electronic (PE) equipment are extensively studied from different aspects. In addition, considering the rapid changes and extraordinary improvements developments brought by the smart grid paradigm, the development of ESSs, DSM, EMS, NMG and resiliency-based MG applications are all emphasized. The contribution of the study is to reveal the structural developments by examining the traditional systems of the MG concept and the modernization approaches provided by new technologies. This paper also identifies and proposes future directions for research in this realm.

### 1.4. Organization of the paper

The study is organized as follows: Section 2 encompasses an overview of traditional MG structure in terms of control architectures, PE-based system components and energy management schemes. Section 3 describes the RESs-based DG integration in MGs, encountered challenges and presented solutions from different aspects. Section 4 introduces modern MG concept and proposed frameworks. Conclusions and future trends are pointed out in Section 5.

## 2. Traditional microgrid architecture

The conventional power systems become insufficient and inefficient in the face of rapidly increasing industrialization and world population. The difficulties and losses in covering the growing demand have given rise to the emergence of the self-sufficient and decentralized MG concept. Extensive studies have been carried out on this framework to deal with many various technical issues.

In traditional MG architectures, demand of end-users with various characteristics has been matched with dispatchable DGs by the system operators. This approach makes possible to keep supply-demand balances with performing such an action in only generation side. End-users are not capable of altering their demand patterns and generating their own energy needs. Questions have been raised about the high electricity prices due to extra reserves. Therefore, significant amount of different implementations with various studies have been performed in this architecture. The conducted literature studies for traditional MGs can be categorized into three main heading as explained in below.

### 2.1. Control/coordination algorithms and strategies

The first serious discussions and investigations of MG concept emerged during the 2000s which draw a general scheme of the architecture, emerging generation technologies and new control techniques [41].

Recently, researchers have shown an increased interested in this concept and the last decade has seen the rapid development in control/coordination technologies to ensure safe interconnection with electrical utility as well as providing high power quality. Among them, Xu et al. [42] developed a finite-time secondary frequency control approach to coordinate multiple DGs in an islanded MG by reducing the frequency deviation and sharing the active power effectively. Neighbor-to-neighbor communication protocol was necessary to implement this optimal control strategy which has supports plug-and-play functionality and distributed data processing capabilities.

Also in [43], power sharing problem of the dispatchable DGs in a grid-connected AC MG was taken into account and a distributed robust hierarchical control framework (including primary and secondary) was

proposed. It is important to state that secondary control dealt with exchanged information of neighboring DGs and their local reference power output bases to determine global synchronous signal in a slow time scale. Primary control was operated in a fast time scale to obtain local reference power output in the existence of uncertain system parameters.

Based on sliding-mode control strategy, Delghavi et al. [44] suggested a current-controlled voltage mode control framework to ensure fast also a stable regulation of output voltage and frequency of the dispatchable DER unit in MGs. The proposed scheme and proportional integral (PI) based control strategy were compared in a sample master-slave organized three-unit MG with the objective of validating its performance.

To address the unbalanced current sharing problems between multiple agents in autonomous DC MGs, a distributed secondary controller was presented in [45]. Cooperating parties for the purpose of ensuring average voltage regulation of the system within a finite settling time was the main issue.

To address the power sharing challenges between various DG units in a complicated MG, the authors in [46] presented a new control and configuration scheme. In this frame, energy server unit capables of providing reactive power while energy routers are supplying active power separately. Finally, Diaz et al. [47] investigated the impact of primary reserve and droop scheduling on stability problem of MG based on the bifurcation theory. Also in [48], a control scheme including primary and secondary controls of an AC MG and besides tertiary control and synchronization loop of an AC MG are illustrated in Figure 1, respectively.

In order to facilitate accurate power sharing between the paralleled DG systems in case of any disturbances/faults occurred in utility side, an unified controller was presented in [49] for multibus MGs which capables of regulating voltage and current as well as determining active/reactive power flow.

## 2.2. MG interconnection and power electronic based system design

PE interface equipments have great deal of benefits that should be considered such as providing flexible operation, achieving reactive power control, regulating voltage and diminishing fault current contributions from DG system. In this respect, Kroposki et al. [50] attempted to present comprehensive investigation by taking into consideration advanced PE interface opportunities in terms of optimal power system operation and meeting the electrical grid requirements.

A three-phase four-wire grid interfacing power quality compensator was developed in [51] which can be used for individual DGs with the aim of enhancing power quality. Thanks to the model, voltage balance within MG was maintained and high quality owing current between utility and MG was achieved. It was indicated that proportional power sharing requirement among the parallel-connected DG systems was also considered in this proposed scheme.

The authors in [52] presented a PE solution for controlling the power flow among the utility grid and high frequency AC MG i.e. a unified power quality conditioner incorporating shunt and series active filters was developed in order to eliminate load current harmonics, voltage distortions while compensating reactive power.

For DC/AC power converters tied with MG and utility grid interface, a  $H^\infty$  repetitive control scheme including a full model of inverter PWM process and a realistic switching frequency was designed in [53]. The key aim of the study was to compensate output voltage harmonic disturbances even under the nonlinear loads existence and/or grid distortions.

Katiraei et al. [54] outlined a control strategy for power electronically interfaced DG units in MG applications. This frame enables to provide angle stability and voltage quality primarily through suppressing the transients.

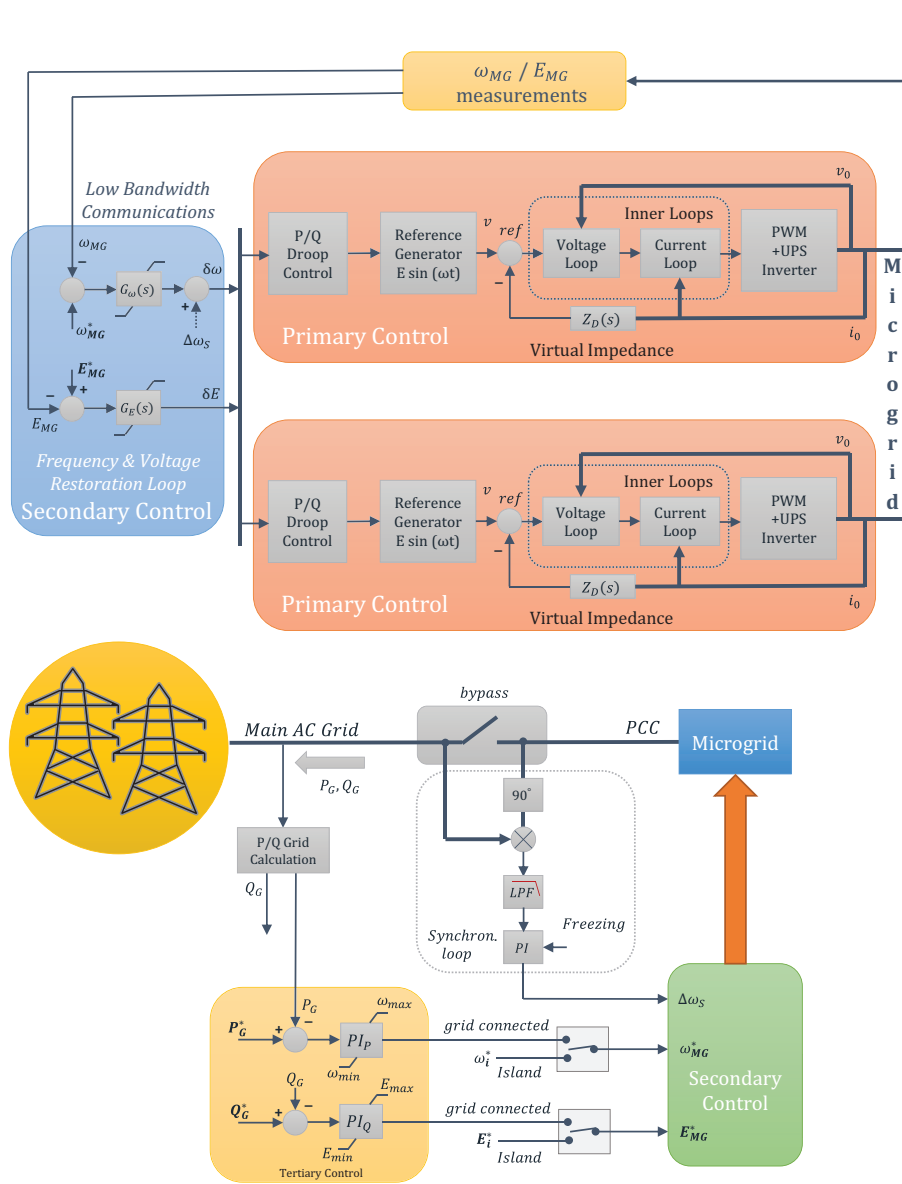

Figure 1. Block diagrams of the hierarchical control of an ac MG adapted from [48].

The study in [55] an appropriate control algorithm was proposed to mitigate voltage dips that the series compensator is capable of eliminating voltage transients, harmonics, and fluctuations especially during the disturbances. Considering the need of an accurate power flow analysis approach for MG applications, Nikkhajoei and Iravani [56] introduced fundamental-frequency, steady-state, and closed form model of PE converter model for the purpose of interconnecting DER units with electrical utility. This proposed scheme can be applied to a voltage-sourced AC/DC/AC converter or the AC/AC matrix converter system which are the intermediate components between parties. For more detail information about widely used PE converter topologies in DC MG, the review study [57] can also be examined.



### 2.3. Energy management system architectures

One major topic in early researches in MG applications was the need of providing optimal energy management schemes to address the requirements of economic operation. Increasing number of literature studies focused on optimization based system modelling. For example, with an objective of reducing fuel consumption rate, a cost optimization conceptual framework was presented in [58] for MGs including various dispatchable and nondispatchable types of power generation systems; two reciprocating gas engines, a combined heat and power plant (CHP), a photovoltaic (PV) unit and a wind turbine. The load demands both electricity and heat should be supplied with constrained by minimum power reserve capacity.

Barklund et al. [59] also dealt with the fuel consumption in droop-controlled islanded MGs. In this respect, an EMS was taken into consideration which has generator dispatch optimization tools, droop selection, and droop stability analysis. It is worthy to indicate that selected droops from a region have importance in terms of providing stability i.e. the dispatchable generator output power was determined by the proposed scheme for minimizing fuel costs and ensuring stable operation.

In grid connected mode, the main aim of the energy management scheme is to ensure economic operation while maintaining power balance has highest priority in islanded mode. Therefore, a double-layer coordinated control approach was proposed in [60] considering different operational modes of MGs and their requirements. To draw an economic operation scheme, forecasting data was utilized in the schedule layer while determining power from dispatchable units based on real-time data handled in the dispatch layer.

From different perspective, a composite storage system containing both high power density storage ultracapacitor and high energy density storage battery was presented in [61] by taking into account operational mode requirements similarly in [60]. Dynamic EMS was in charge of providing the supply-demand balance in islanded mode. However, volatile output power of RES-based DG and also load fluctuations were eliminated in grid-connection. With the purpose of designing an optimal network architecture in medium- and low-voltage level for MGs, a great deal of network structures were developed and discussed in [61].

Computational intelligence methods, particle swarm optimization (PSO) and ant colony optimization based power management scheme were examined in [62] for facilitating transformations from traditional MG to next-generation modern network. It is to be highlighted that methods should present effective solutions in terms of low computation burden especially in multiobjective optimization environment. For more detailed information about proposed EMS for traditional MGs, the review study [63] can be investigated.

Recently, there is a strong trend towards to increase the rate of renewable-based DERs in the smart MG due to the growing concerns for environmental issues and climate change all over the world. In this context, there is an extraordinary quickening rate in small-capacity distributed generation (DG) technology for especially of grid areas with ever-increasing demand. As a result the traditional network operation, in which electricity is transmitted from the large-scale central energy plants far away from the end-users' premises, has changed significantly.

### 3. MG with renewable energy resources based distributed generation penetration

In order to decrease grid independence, the importance of modular and distributed RESs for power network increases over time in recent years. High amount of losses in transferring power from further centralized plants to end-user premises and global warming issues enforce to be transformed from conventional grid to smart modular architecture. Political and economic facts also motivate the boosting deployment of DGs in a worldwide along

with environmental impacts. The worldwide expanding proportions of RES-based electrical energy generation can be seen in Figure 2. However, power output patterns of RES-based resources are strongly depended on their intermittent and weather depended characteristics without doubt. System operators have to deal with their uncertain profiles and present an effective solution. Such nondispatchable generation units may possibly cause stability issues and power quality disturbances in the power systems which are to be handled with several energy management axioms [5]. The integration of RES can be discussed under three headings, which are control/coordination algorithms and strategies, MG interconnection and power electronic based system design and lastly energy management system architectures as explained in below.

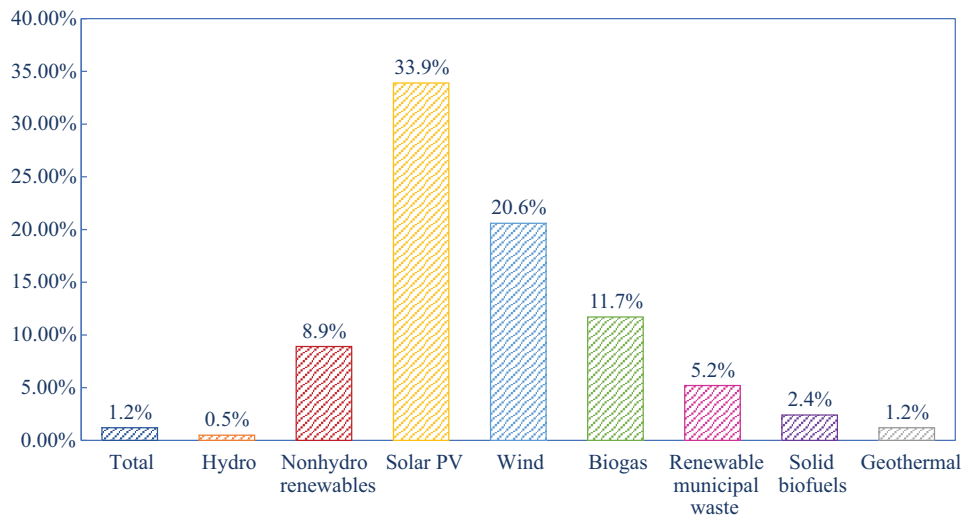

**Figure 2.** Growth of world renewable generation over the total electricity generation (2019) [34].

### 3.1. Control/coordination algorithms and strategies

With the aim of increasing penetration of RESs into the MG, control and coordination frameworks were widely investigated in the literature to cope with its random nature. Also, regulating frequency/voltage for higher power quality and providing sustainable distribution system operation are all main aims behind the conducted studies.

The study in [64], a novel control strategy was proposed for DC MG consisting of PV generation, batteries and loads in order to achieve seamless interconnection to the utility grid and to guarantee fast detection of islanded operational mode. There is important to install a proportional-integral regulator in the MG central controller with the aim of aligning voltage of the MG and power network during reconnection through sending setpoints to the voltage forming unit (batteries) by the PI regulator. Mi et al. [65] presented a novel droop control strategy by taking into account the uncertainties caused by renewable energy generation units and load disturbances in practical islanded DC MG. It was stated that the nonlinear nature of output power and voltage magnitude can be modelled with Takagi–Sugeno fuzzy model with utilizing locally measured output variables. As a result, the proportional power sharing was accomplished with eliminating uncertainties and disturbances.

In order to increase overall RESs-based generation units capacity in the MGs, a hierarchical distributed model predictive control method was suggested in [66] by enabling power exchange with transmission network. Intermittent renewable sources and variable load demand can cause some important challenges in MG operation

side that should be considered. In order to address this concern, a distributed secondary control approach was outlined in [67] for providing accurate active power sharing and frequency restoration with flexible convergence time in an autonomous MG. The study in [68] showed that the overall voltage variations can be minimized as well as achieving accurate reactive power sharing in an islanded MG consisting of highly penetrated RESs by developing a fully distributed discrete two-level control strategy. The upper and lower-level control systems deal with determining the active/reactive power generation references and tracking these references, respectively. The effectiveness of the proposed scheme was demonstrated under different operating conditions such as load disturbances and communication channel failures in simulations. Also in [69], a control method was suggested for managing and coordinating converter connected power sources e.g., PV, wind and storage units with the aim of obtaining appropriate active current which determined by maximum power point tracking/state-of-charge (MPPT/SOC) in the local control system. Outer loop and secondary control layer deals with DC bus voltage and frequency/voltage magnitude at the load bus, respectively. Basic hierarchical control structures of MGs are shown in Figure 3 [43].

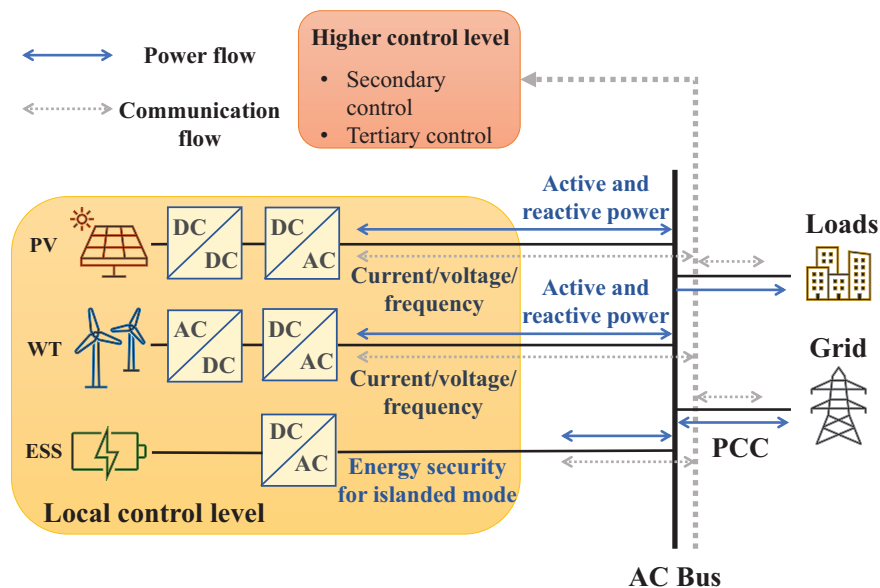

**Figure 3.** Basic hierarchical control structures adapted from [43].

Furthermore, a decentralized generation-storage coordination control strategy was presented in [70] to prevent DC bus voltage overrising and overuse of the storage system degradation improving discharging and charging strategies for islanded MGs. Also, the output power of the PV generators can be regulated by MPPT based on the DC bus voltage with the aid of adaptive power control technique. Chauhan et al. [71] proposed a conceptual framework for islanded MG consisting of nondispatchable fixed-pitch variable-speed wind generator and a battery energy storage system (BESS). In this frame, BESS was in charge of regulating the PCC's voltage and frequency between the accepted ranges in case of demand/wind power deviations. It was stated that critical loads were supplied each time of the period with an uninterruptable power even in different operating modes and transitions thanks to this proposed scheme according to the simulation results.

Power sharing, economic dispatch, controlling load-side and generator-side transients should be taken into consideration for MG operation both in islanded mode and grid-connected especially in increased penetration

of RES-based DGs. The study in [72] showed that system dynamic performance can be improved with a novel PID-based optimized control solution in which is possible to provide optimal power sharing and tradeoff cost optimality between DGs.

Duan et al. [73] propounded a novel distributed control scheme for inverter-interfaced MGs that primary control is responsible for regulating bus frequency and voltages by suppressing the transient line currents while secondary control aims at achieving fair load sharing. The stability analyses as well as extensive simulations were conducted to show presented solution effectiveness. In [74], the Authors designed a controller for hybrid islanded DC MG consisting of solar PV system, a diesel generator with rectifier, loads, and a BESS. The main purpose of the study were to provide a constant DC-bus voltage where mentioned components were assumed to be connected this DC-bus directly or indirectly. Also, supply-demand mismatch was minimized thanks to the developed controller. It was stated that the effectiveness of the presented algorithm was demonstrated under different operating scenarios. To address the optimal active/reactive power sharing, frequency restoration and output voltage control problems in DG based MGs, Chen et al. [75] proposed the distributed secondary control schemes investigating the impact of communication delays. This study followed a case-study design, with in-depth analysis of stability and sensitivity.

Recently, the distributed control of MGs based on multiagent system graph theory has become a popular topic. Ullah et al. propounded a multiagent consensus based distributed control algorithm in [76] with the aim of achieving multiple objectives in a simultaneous fashion. Hierarchical control structure of the battery energy storage systems (BESSs) and the frequency/voltage droop controllers were taken into consideration. Economic dispatch, the synchronization of the active and reactive power as well as frequency and voltage regulation were provided. In addition, performance analyzes were performed by comparing the proposed distributed control structure with the distributed PI-based conventional control strategy. Also in [77], a fully-distributed and delay-tolerant robust secondary control scheme was developed for droop-controlled AC microgrids. The hierarchical control structure of the DER units in the test MG has been designed for only requiring the information of MG's and its neighbors. The proposed technique not only increases the reliability of MG operations, but also regulates active power sharing between DER units.

It is clearly obvious that an increasing number of literature studies have examined the effects of intermittent RES-based DG units, variable load demand, changing operating mode of MG on the system operation and voltage/frequency regulation from different aspects.

Bose et al. [78] highlighted the need a new frequency estimation technique especially during the transient conditions and proposed a controller approach based on virtual synchronous machine speed to enhance dynamic behavior of MG with fast responding in any sudden change. The study in [79] provided an exciting opportunity to advance our knowledge of hierarchical control algorithms with enabling connection of wind turbine, BESS-based MG and weak grid. One of the main aims of this investigation was to achieve a fast frequency restoration through seamless interconnection with weak grid by managing the tie-line active power of the MG considering the grid needs.

To address the integration challenges of RESs- based DG units in MG, there is a considerable number of literature studies to improve control/coordination strategies [80–82]. The taxonomy of relevant literature consisting of control strategies, using methods, various DG resources as well as AC and DC MG architectures as indicated in Table 2. More detail reviews devoted to the topic can also be found in [12, 35, 83, 84].

**Table 2.** Relevant background of literature studies considering different control methodologies and DG resources.

Authors (Year)	Control tec.	Method	Purpose	On-grid	PV	WT	MT	Diesel	FC	TG	DG	ESS	SC	AC DC	Ref.
Xu et al. (2019)	Optimal distributed control	Secondary frequency and voltage regulation	Coordination of multiple distributed generators	No	-	-	-	-	-	-	✓	-	-	AC	[42]
Delghavi and Yazdani (2019)	Sliding-mode control	Master-slave-organized inverter-based	Fast and stable control on the terminal voltage and frequency of DER unit	No	-	-	-	-	-	-	✓	-	-	AC	[44]
Sahoo and Mishra (2017)	Distributed secondary control	Conventional tracking protocols based on asymptotic convergence	Finite time voltage regulation and proportionate current sharing between multiple agents	No	-	-	-	-	-	-	✓	-	-	DC	[45]
Wang et al. (2019)	Practical Structure and control	Energy routers and energy services	Active power and reactive power sharing	No	-	-	-	-	-	-	✓	-	-	AC	[46]
Diaz et al. (2010)	Frequency and PQ control	Bifurcation theory	Scheduling the drooping characteristics for frequency (and voltage) regulation	No	-	-	-	-	-	-	✓	-	-	AC	[47]

Table 2. (Continued).

Authors (Year)	Control tec.	Method	Purpose	On-grid	PV	WT	MT	Diesel	FC	TG	DG	ESS	SC	AC DC	Ref.
Kleftakis et al. (2019)	MG central control	Proportional integral-derivator	Seamless interchange method between interconnected and islanded operational mode	Both	✓	-	-	-	-	-	✓	✓	-	DC	[64]
Mi et al. (2019)	Linear droop control	(T-S) fuzzy model, sliding mode alg.	Intelligent power sharing	No	-	-	-	-	-	-	✓	-	-	DC	[65]
Hans et al. (2019)	Predictive control	Hierarchical distributed model	Increasing the overall infeed of RESs	Yes	-	-	-	-	-	✓	✓	✓	-	AC	[66]
Deng et al. (2019)	Secondary cont.	Lyapunov method	Frequency restoration and accurate active power sharing	No	-	-	-	-	-	-	✓	-	-	AC	[67]
Xu et al. (2019)	Two-level cont.	Droop control, ZOH method	Minimizing the overall voltage deviations while achieving accurate active/reactive power sharing	No	-	-	-	-	-	-	✓	-	-	AC	[68]

Table 2. (Continued).

Authors (Year)	Control tec.	Method	Purpose	On-grid	PV	WT	MT	Diesel	FC	TG	DG	ESS	SC	AC DC	Ref.
Yallamilli and Misra (2019)	Centralized control	Instantaneous symmetrical component theory	Power management of hybrid MG connected to the grid	Yes	✓	-	-	-	-	-	-	-	-	AC DC	[85]
Dehnavi and Ginn (2019)	Distributed control	MPPT/SOC, cont. of active and reactive power	Independent sharing of tasks among sources	No	✓	✓	✓	-	-	-	✓	✓	-	AC DC	[69]
Xia et al. (2019)	Decentralized control	SOC/MPPT	Realizing the generation-storage coordination based on the DC bus voltage signaling	No	✓	-	-	-	-	-	✓	-	-	DC	[70]
Chauhan et al. (2019)	Regulation the PCC voltage/freq.	Active-reactive power cont. of the WG	Regulating the PCC voltage and frequency, proper synchronization and disconnection of the WG	No	-	✓	-	-	-	-	✓	-	-	AC	[71]
Ahmad et al. (2019)	Distributed control	Economic dispatch, PID	Economic dispatch with improved dynamic performance	Both	✓	✓	-	-	-	-	✓	-	-	AC	[72]

Table 2. (Continued).

Authors (Year)	Control tec.	Method	Purpose	On-grid	PV	WT	MT	Diesel	FC	TG	DG	ESS	SC	AC DC	Ref.
Duan et al. (2019)	Distributed cont. scheme	Regulate voltages/freq load sharing	Regulating the bus voltages and frequency, maintain fair load sharing	Both	-	-	-	-	-	-	✓	-	-	AC	[73]
Roy and Mahmud (2018)	Nonlinear back-stepping control	Lyapunov theory	Minimizing the mismatch between the generation and consumption while maintaining a constant DC-bus voltage	No	✓	-	-	✓	-	-	-	-	✓	DC	[74]
Chen and Guo (2019)	Secondary control scheme	Lyapunov-Krasovski functions	Novel secondary voltage and frequency restoration, the optimal active power sharing, and the accurate re-active power sharing	No	-	-	-	-	-	-	✓	-	-	DC	[75]



Table 2. (Continued).

Authors (Year)	Control tec.	Method	Purpose	On-grid	PV	WT	MT	Diesel	FC	TG	DG	ESS	SC	AC DC	Ref.
Ullah et al. (2020)	Distributed control	Consensus based SoC trajectory tracking control	Maximizing the power capacity of the ESSs all the times	Both	-	-	-	-	-	-	-	✓	-	AC	[76]
Ullah et al. (2021)	Hierarchical control	Consensus-based delay-tolerant distributed secondary control	Equal active power sharing between three DER units	Both	-	-	-	-	-	-	✓	-	-	AC	[77]
Bose et al. (2016)	Freq. Regulation of MG	Double second-order generalized integrator phase locked loop	Frequency regulation of MG during transient conditions	No	-	-	-	-	-	-	✓	✓	-	AC	[78]
Zhao-xia et al. (2019)	Hierarchical control	Controlling power flow, frequency regulation	Provide a coordinated frequency support to a weak grid	Yes	-	✓	-	-	-	-	-	✓	-	AC	[79]
Iovine et al. (2019)	Voltage and power control	Lyapunov techniques	Efficient renewable energy integration	Yes	✓	-	-	-	-	-	-	✓	✓	DC	[80]

Table 2. (Continued).

Authors (Year)	Control tec.	Method	Purpose	On-grid	PV	WT	MT	Diesel	FC	TG	DG	ESS	SC	AC DC	Ref.
Baghaee et al. (2017)	Sliding mode control	Lyapunov function	Improve small and large-signal stability and power-sharing of hybrid AC/DC MGs and improve its performance for nonlinear and unbalanced loads	No	✓	✓	-	-	✓	-	-	-	-	AC DC	[81]
Baghaee et al. (2018)	Decentralized sliding mode, voltage control	Robustness/closed-loop stability analysis, Lyapunov function	Controlling of power/current/voltage/frequency	Both	✓	✓	-	-	✓	-	-	-	-	AC	[82]
Vazquez et al. (2019)	Decentralized droop control	Perturbation and observation method	Minimizing power loss	No	✓	-	-	-	-	-	-	✓	-	AC	[86]

### 3.2. MG interconnection and power electronic based system design

There are several studies in the literature [87–89] which systematically reviews the PE interface-based MG architecture with in-depth analysis of various operating conditions and system requirements.

Increasing penetration of solar PV systems, ESSs, fuel cells on the generation side while growing applications of DC loads such as electric vehicles paved the way for making AC/DC hybrid MG one of the most widely-used topology in smart power distribution system. Thus, a large and growing body of literature has conducted on PE equipments to solve integration challenges in recent years. Among them, Jia et al. [90] proposed a multiterminal (one AC terminal and two DC ports) hybrid AC/DC MG architecture consisting of cascaded H-bridge converters based AC grid interface and two dual active bridge (DAB) converters based DC grid interface. They capable of transmitting power to medium-voltage grid directly and reducing the number of conversion stages, respectively. It has been conclusively shown that three-phase grid currents and DC capacitor voltage balance were achieved simultaneously even in the worst case studies. Vuyyuru et al. [91] performed a simulation on the MATLAB environment to show that series voltage regulator concept is effective for radial DC MG in terms of compensating voltage drop along the line resistance and keeping the load bus voltage between the accepted limits. DAB a full-bridge DC-DC converter and DC-DC converter are the basic topological elements of the series voltage regulator in which is possible to regulate the DC bus voltages under different conditions without affecting the load variation.

The study in [87] developed an optimal strategy that consider the network of multiple DC-DC converters as a DC MG with the objectives of regulating the DC-link voltage effectively despite of uncertainties and variations. The time-varying current sharing between sources was ensured in this model.

It was to be emphasized that there have been increasingly rapid advances in PE sector which enabling high quality of customer services, reliable, resilient and robust MG structure with increasing the accommodation of RESs-based DG units in the electrical system. In order to maximize output power production of PV sources, a high-efficiency active-boost-rectifier-based converter was designed with a novel modulation method in [88]. This study aimed to make an important contribution to the field of accelerating RES-based DG integration into the MG. The working principle of this converter was based on a series resonant converter in which possible to reach highest efficiency in nominal input voltage condition. Moreover, low-irradiance or shadowed conditions for PV system was taken into account. The proposed scheme enabled converter to operate with the new developed "double-pulse duty cycle" modulation for increasing the output voltage for appropriate DC MG connection.

Adly et al. [92] designed a conceptual framework for module integrated converters with the aim of solving integration challenges of mismatched and partially-shaded PV modules by performing minimum amount of sensors. According to practical implementation, the global MPP tracking approach was capable of providing fast and accurate MPP tracking without any periodic scanning or oscillations. Furthermore, a substantial reduction in the converter losses can be achieved by allocating PV operating point efficiently thanks to the proposed alternative output voltage regulation approach.

In order to maximize output power production of PV sources, a high-efficiency active-boost-rectifier-based converter was designed with a novel modulation method in [88] that aims to make an important contribution to the field of accelerating RES-based DG integration into the MG. The working principle of this converter was based on a series resonant converter in which possible to reach highest efficiency in nominal input voltage condition. Moreover, low-irradiance or shadowed conditions for PV system was taken into account and the proposed scheme enabled converter to operate with the new proposed "double-pulse duty cycle" modulation targeting the increase output voltage for appropriate DC MG connection.

Energy routers are the fundamental components of the PE based DC MG cluster which should have the important capability such as improving the control axioms on flowing power between MG and AC utility grid to supply electrical load considering stochastic nature of RESs. Therefore, the authors in [89] described the design of a novel modular based energy router to offer some important insights into extending the operational functions of energy router. It is worthy to indicate that the presented scheme consisting of an isolated DAB converter and AC/DC converter with high frequency transformers. It provides important opportunities in terms of facilitating match the demand in different DC voltage levels, isolate the fault easily and reduce the investment costs.

### 3.3. Energy management system architectures

In order to address the requirement of fast detection dynamic security status for RESs-based MGs, a three-stage adaptive protection framework was described in [93] by considering long fault clearing time and low inertia of inverter-based DGs. In the first stage, it was necessary to establish dynamic security models with the online analyses. This model was now the input of secondary stage for online calculation of equilibrium points, regions of attraction, and protection zones for the synchronous generator-based and inverter-based DGs. Also, the third stage was in charge of real-time protection.

An intelligent fault detection scheme was proposed the study in [94] with the goal of providing the information of fault type, phase and location for MG controller based on wavelet transform and deep neural networks. Firstly, branch current historical data was to be preprocessed with discrete wavelet transform to draw a general scheme. Then, fault type was determined by utilizing this available data integrated into neural network.

Soleimanisardoo et al. [95] represented a novel protection framework for islanded MG which enables highly penetrated inverter-based DGs on the generation side by taking into consideration their injected fault current levels. Thus, the system structure able to evaluate injecting off-nominal frequencies thanks to DG interface throughout the fault conditions with the purpose of identifying the type and isolating fault.

The study in [96] offered a framework for detecting the fault and identifying its location in order to improve power quality and reliability of DC MG with utilizing the oscillation frequency and related transient power in the first cycle of the oscillation, respectively. The performance of the propounded strategy was evaluated through simulations based on the local data taken from PSCAD/EMTDC with a great deal of case studies consisting of bidirectional power flow situation, high fault resistance, and different fault types.

The authors in [97] presented a specific fault detection strategy considering grid-connected DGs' fault characteristics which strongly associated with their low voltage ride-through capability. In the high-impedance faults and low-impedance faults conditions, the new proposed algorithm was tested to find the location of the faulted point with utilizing the data of phase differences between the positive-sequence fault component of the bus voltage and the positive-sequence fault components of the currents in the feeders. It is highlighted that this scheme made an great opportunity to determine all faulted feeders i.e. the main feeders and the branch feeders which does not affected by the fault resistance and also less sensitive to the changes in load demand.

Although DC MG architecture presents a great deal of opportunities than the AC one, development of this structure has been mostly restricted by virtue of immature protection system design. To address this issue, Reference [98] attempted to evaluate the cable fault characteristics of the PV powers including pole-to-pole fault process and pole-to ground fault process by dividing into multi stages. Also, a more reasonable converter structure and a transverse differential protection scheme were represented by taking into account common obstacles.

#### 4. Modern MG architecture and operational flexibilities

Large-scale poor existing power system has experienced tremendously important changes in both generation and demand side as shown in Figure 4. MGs are dominated by RESs-based DG units and different types of prosumers capable of on-site generation, altering demand pattern, participating electricity market and trading for maximize their profit. Recent advances in smart grid technologies have facilitated for developing massive practical MG applications and also make several noteworthy contributions to the current literature. The literature studies for modern MGs can be classified into four main headings as expressed in below.

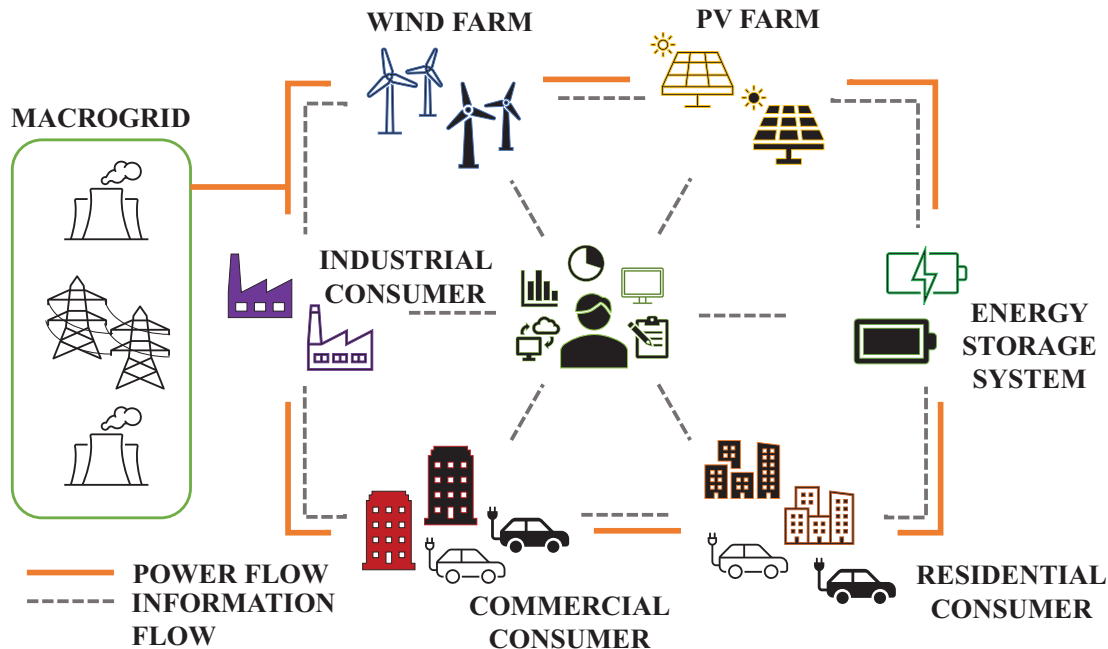
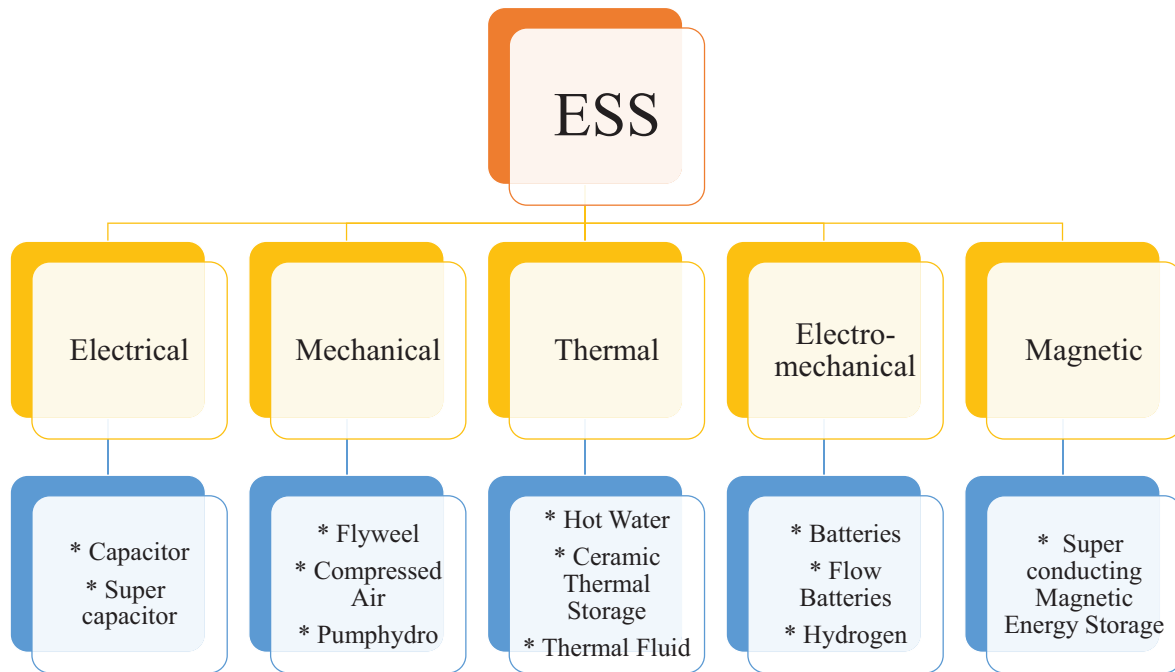

Figure 4. The illustration of smart microgrid structure.

##### 4.1. Energy storage systems

A considerable amount of successful studies have systematically examined the large-scale implementation of RESs and pointed out the spinning reserve should become necessary part of the MG to overcome all mentioned challenges [6]. ESSs such as flywheels, pumped hydro, compressed air storage, and superconducting magnetic sources can respond very quickly to load fluctuations [23]. Therefore, they occupy an important place in managing imbalance situations for network operations. In another aspect, they play an active role in MG's island mode applications, which are used to increase network reliability. Thanks to these applications, dependency on the grid, energy and operation costs can be substantially reduced [36]. Various ESSs-based units can be used as a primary source of energy in the MG architecture. Figure 5 [37] divides them into five main groups which are electrical, mechanical, thermal, electrochemical and magnetic.

As a result of strategic developments to manage grid operations, electric vehicles have become an alternative storage system to be used in MG applications, with the ability to operate in vehicle to grid and grid to vehicle modes [99]. The increasing influence of EVs has led to the concept of using EVs as backup storage units or ancillary service providers in maintaining supply-demand balance for the power system planner. However, especially social, technical, policy and infrastructure challenges need to be resolved in order to use such potential



**Figure 5.** Different energy storage system categories [37].

power sources as part of demand side management (DSM) strategies in the context of smart grids [23]. The integrated operation of EVs and MGs was extensively investigated with growing body of literature such as in [100–105] and also more detail reviews devoted to the topic can also be found in [23, 38, 39]. The findings of these approaches/strategies have a number of important implications for future practices.

There is a growing body of literature that integrating the ESS-based DER and mobile EVs into the MG controller to provide predefined voltage/frequency ranges for normal operational conditions. With incorporating statistical learning advances into real-time energy management, an online learning-aided management framework was developed in [106] for smart MGs consisting of RESs-based DG and ESS. Providing economic operation by reducing the required battery capacity was the main target of the study. It is worthy to indicate that this scheme has ability to cope with the intermittent nature of RES. Besides, it paved the way for facilitating real-time implementation with integrating alternating direction method of multipliers technique.

Two novel coalitional game theory based optimization methods were presented in [107] for smart community consisting of households in which some of them can capable of producing their energy from on-site generation with RES, some of them are also able to store excess energy in ESS while other residences are normal energy consumers. This proposed framework enabled to exchange power in neighbourhood region and to share the sources considering optimal operation in terms of reducing energy costs for both prosumers and simple consumers. The accurate predictions of load demand as well as RES generation allowed to implement such strategies effectively thanks to the installed smart energy meters.

Among them, the study in [108], a novel primary control strategy was proposed for MG in order to utilize BESS' fast responding capability especially in disturbance events. It is important to emphasize that this new structure was acquired the tracking of voltage and frequency set points accurately which accepted as the main shortcoming of droop-based control techniques. Simulation results were presented to highlight the

effectiveness of the proposed method in mitigating transients and improving the system dynamic performance for a medium-voltage MGs in MATLAB/Simulink environment.

An adaptive dynamic programming (ADP) based frequency control strategy was developed in [109]. In this intelligent control system, PV power and load uncertainties were accepted as parameters and the power outputs of the microturbine and ESS can be adjusted to prevent frequency fluctuations. In addition, it was observed that the designed frequency control system has a better adjustment capacity than the fuzzy control, linear quadratic regulator controller and PID controller.

To tackle the system stability problems, a flexible voltage control strategy was investigated in [110], which is able to mitigate the node voltage variations in DC network and to respond the frequency changing in AC network. Unlike the current optimization methods, this method presents a free of communication structure which can be evaluated as one of the most important opportunity and also facilitating the practical implementation by virtue of its feasibility.

A robust optimal control model has been propounded in [111] for ESS to provide the best economic operation as much as possible in grid-connected MG considering cost reduction, precise control and external effect. A mixed integer linear programming (MILP) based formulation was used to model control problem while the state of energy level was calculated by the piecewise linearization technique. For achieving the global optimum solution, problem was solved in every period with using updated values thanks to the rolling horizon controller scheme.

Badwawi et al. [112] developed a fuzzy logic controller for BESSs which is a good candidate to ensure power balance in the extremely variable power production and consumption periods. The present study offered a conceptual framework for performing battery ESS in a safe manner i.e. the state of energy and discharging/charging power of the battery were to be constrained by taking into account its specifications. Also in [113] provided a new ADP algorithm for ESS consisting multiple battery units with the goal of coordinating all of them within the accepted operational ranges to increase battery lifetime. Unlike the most of the existing literatures, the study presented in [114] take the battery lifetime extension problem into consideration from different perspective in which is important to adjust controllable microturbines' output power with a stochastic manner.

Apart from the stability challenges, resiliency of the MG architecture should be taken into consideration which has significantly widespread consequences caused by the blackouts. Thus, the study in [115] dealt with the incorporation of transportable ESSs into the MG operation and a joint postdisaster restoration framework was proposed in order to utilize their great potential in the field of enhancing system resiliency. The findings from this study make several contributions to the current literature comparing stationary batteries flexibility and cost reduction capability. Also the problem was formulated as a two-stage optimization-based in [116].

As mentioned in previous studies, ESSs are one of the most important units that can provide flexibility and reliability in MG operation. However, sizing of ESS, on the other hand, is the main challenges when considering huge installation costs. As an example, in [117], production costs and reliability indices were calculated in two cases to see the effects of joining ESS to MG. In addition, dynamic programming was used while solving the unit commitment problem for both cases in calculating the production cost. The study was handled in a wide scope in which larger intermittent DG penetration can be included in the system.

#### 4.2. The demand-side management concept

Besides the mentioned ESS technologies, the concept of demand side management (DSM) has drawn significant attention and presents a promising solution for system operators due to maintaining voltage/frequency stability, deferring generation plants construction, and increasing energy efficiency [118]. Normally, energy generation increases in response to an increase in end-user's demand in traditional power system operation. However, ever-increasing demands as well as widespread adoption of DGs enforced to change the mentality. And demand side become new axiom area with the help of outstanding developments in the fields of smart grid technology. Demand response (DR) is one of the most popular techniques of DSM which enables end-user's to reduce/shift their electricity consumption in response to electricity prices or operator's requests [119]. The communication and information technologies also an advanced metering infrastructure enable two-way communication between the utility company and the end-users for implementing load shifting/load reduction strategies by taking into account operational benefits in controllable platform of smart MG [120]. The classification of various DR strategies in the studied literature as illustrated in Figure 6 [40].

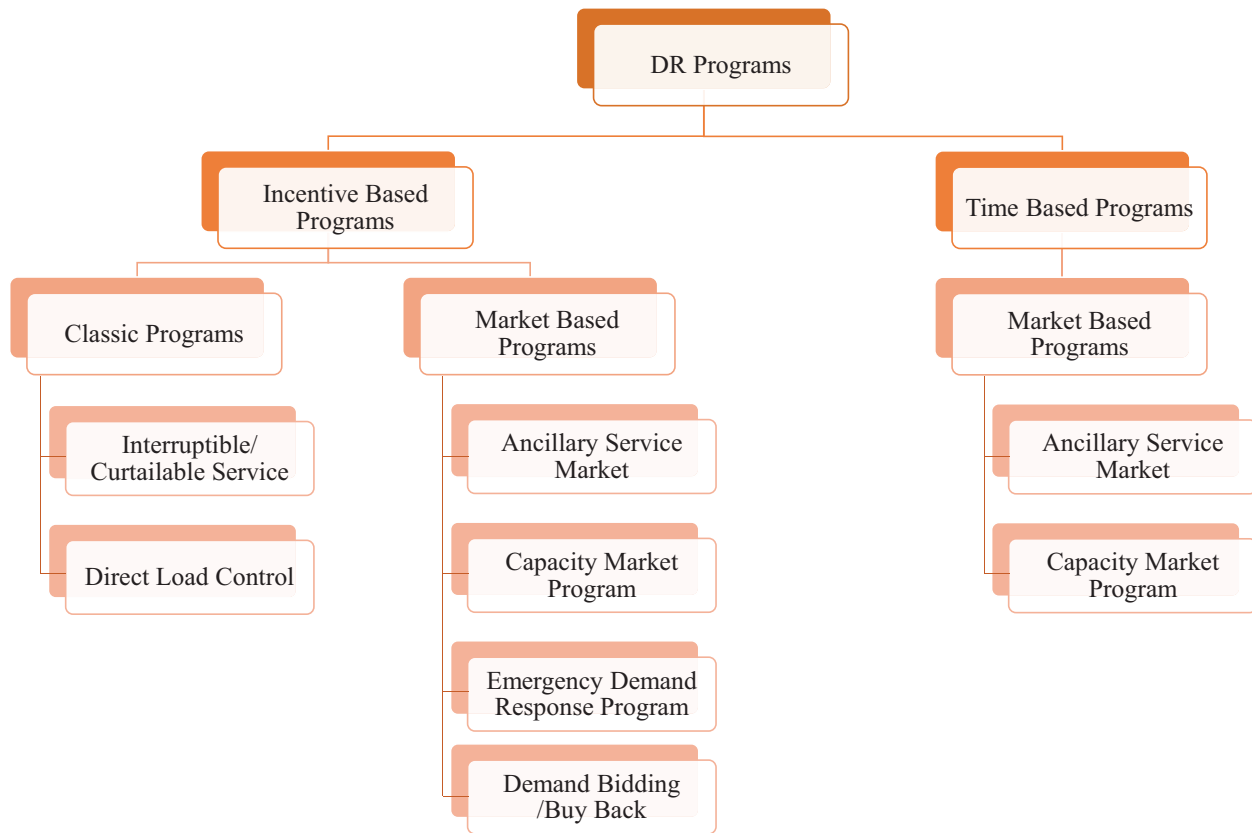

**Figure 6.** Classification of DR programs [40].

From the MG system operator's perspective, the uncertain nature of RESs-based DG units, variable load demand of end-users and volatile electricity market prices can cause severe operational difficulties. To address these mentioned challenges, a two-stage robust coordination strategy has been developed in [121] that day-ahead price-based demand response program (PBDR) and dispatchable microturbines were coordinated for ensuring optimal operation of MGs. A day ahead PBDR strategy was planned based on the predictions



of nondispatchable DG output power and demand; controllable DGs were scheduled and optimized hourly to compensate variations in the first and second stage, respectively.

A new voltage unbalance mitigation framework in islanded MGs coordinating the generation and demand side sources, PV grid-tied inverters and thermostatically controllable loads, has been presented in [122] with the objective of improving reliability, power quality and security issues. It was reported that the regulation of voltage unbalance factor was obtained between the accepted ranges defined by IEC and CIGRE Working Group 36.07 according to the extensive simulations and real-time simulators results.

Unlike the existing literature studies based on off-line DSM strategies, a two-stage real-time DSM method for MGs was investigated in [123] to minimize the daily total cost as well as providing the production consumption balance with dealing frequent deviations caused by RES.

Also in [124], an event-driven automatic demand response scheme has been proposed to operate grid-connected residential MGs with online manner which consisting of RES-based DGs, a stationary ESS, multiple households and plug-in electric vehicles. The main aim of this study was to ensure optimal operation of MG with maintaining power balance, managing various events effectively while minimizing the total energy cost.

A joint optimization model was proposed for grid-connected residential MG with DSM services in [125]. In this model residential MG includes PV units, wind turbines, microturbines, diesel engine generators and BESSs. The optimization problem, which aims to minimize the annual cost of MG and emission, was solved by the MILP method. It was concluded that as the level of participation increases, the proposed MG planning and operating model can provide better solutions and maximize RES integration.

In [126], a risk-averse multistage stochastic heterogeneous energy storage deployment method in a residential multienergy MG considering multienergy DSM was presented. In this method, uncertainties arising from RES-based generators, outdoor temperature, and hot-water needs were taken into account. The case studies showed that DSM integration is profitable for HES and the proposed method can properly manage uncertainties and system risks.

Aderibole et al. [127] considered a conservation voltage reduction strategy for voltage source inverter-based autonomous AC MGs with the purpose of providing voltage compensation to adjust bus voltage within the permissible range. It was validated with simulations that increasing power demand (in peak periods and overloading conditions) results in deviating the bus output voltage magnitude and frequency which can be eliminated through proposed scheme by integrating load shedding algorithm into the control structure.

The authors in [128] developed a PBDR management framework for a smart MG in order to mitigate the negative impacts of volatile market pricing while ensuring optimal solution for both utility and end-users with utilizing the AMI infrastructure. The investigation of PSO and artificial immune system methods in implementing DR strategies were examined by simulations.

The effects of DSM techniques on MG portfolio, sizing and placement were criticized in [129]. In this study, it was aimed to minimize the cooling load electricity price and optimize all operating and investment costs of MG by using DSM model. An example comparing smart HVAC control and traditional HVAC control on MGs was investigated and the results show that load control with DSM techniques causes a significant reduction in annual energy consumption and cost of MG.

### 4.3. Energy management system architecture

In recent years, there has been an increasing number of literature studies on EMS strategies that takes different combined structures into account for providing optimal operation of MGs. Abedini et al. [130] developed a

novel algorithm for autonomous MGs consisting of diesel hybrid/PV/wind energy system in order to minimize capital investment and fuel costs of the system as well as to find the optimum design of these units. Conti et al. [131] presented an optimization algorithm targeted at reducing fuel-based dispatchable generating systems ratio in MGs by enabling the optimal dispatching of RES and ESS with the aim of minimizing pollutant emissions and operating costs. The study in [132] suggested a stochastic day-ahead power scheduling framework by employing grey wolf optimization algorithm with specifically concentrated on intermittent nature of RES and unpredictable/uncertain load demand in MGs considering economic and reliability aspects. Chaouachi et al. [133] proposed a multiobjective intelligent energy management control scheme by aiming at minimizing operational costs as well as the environmental impact of the MG.

In [134], various energy management strategies based on fuzzy logic controllers which designed to smooth the grid power profile of a residential grid connected MG was reviewed in detail. Two MG architectures were designed consisting of wind, PV generation and uncontrollable household electrical loads. Battery charger/inverter has been considered as controllable component in the first structure while thermal load has also been added to second structure as controllable component as well. Arcos-Aviles et al. [135] aimed to minimize the grid power profile fluctuations with proposing fuzzy logic control based EMS for residential grid connected MG. Battery SOC as well as MG energy rate-of-change have been taken into consideration instead of forecasting methods while scheduling power exchanges with the main grid. On the other hand, it is seen that generation and demand forecasting models were integrated into proposed EMS structures for RES and ESS based residential MGs in [136] and [137]. In addition, the controllability of loads such as domestic hot water and heating, ventilation and air conditioning in residential MGs was evaluated in [138]. It was highlighted that systems such as controllable loads, electrical and thermal storage will support the development of RES penetration in the MGs.

It is clearly seen that a great number of researches are available in the literature incorporating the most widely-used flexible energy option of DR mechanisms into the EMS in order to address major operational issues and maximize RES integration in MGs. In this manner, Dietrich et al. [139] investigated the effect of different DR options such as peak shaving and demand shifting on the islanded MG operation and the optimization problem was modeled by using associated cost and price elasticity coefficients considering high wind penetration.

Pourmousavi et al. [140] presented a multitime-scale power management algorithm aiming at providing safe operation for islanded MGs by coordinating generation, storage, and the DR source of EWH within the same management framework. Tsikalakis et al. [141] described a central controller model for MGs including DGs, different types of consumers such as commercial, residential, and ESS under actual dynamic market prices. Subsequently, two market policies were investigated according to the different economic aspects e.g., minimizing the MG operational costs as well as maximizing the MG central controller's profit by using DR applications.

Bui et al. [142] presented EMS based on a multiagent system consisting of load, ESS, central agents etc. so as to analyse all possible strategies and choose most economic and optimal mode for MGs. Additionally, DR was considered and provided a reduction in operational costs by using MILP framework with low computational burden. Alharbi et al. [143] proposed MILP based EMS strategy which schedules charging/discharging strategies of ESS under a DR program in order to mitigate supply-demand mismatches with high penetration of RESs for MG.

Developments in subjects such as machine learning, internet of things (IoT) and artificial intelligence have also led to emerge new approaches in MG applications. Çimen et al. defined an efficient nonintrusive load monitoring (NILM) based EMS and verified this mathematical model on a residential MG in [144]. In

the study, average power consumption, operation cycles, preferred usage periods, and daily usage frequency of the appliances were estimated with high accuracy. This EMS operates controllable loads, taking into account customer comfort, together with the dispatch of DG units. The NILM-based EMS model has been found to improve operation cost/customer satisfaction ratio by 45%-65% compared to a traditional EMS.

Also in [145] the authors proposed a hybrid approach for short-term forecasting of load demand to manage power in MG effectively. This hybrid model was a combination of the best-basis stationary wavelet packet transform and Harris hawks optimization based feed-forward neural network. With the proposed model, the load demand on working and weekend days of summer, autumn, winter and spring can be predicted.

These aforementioned references with many other studies not referred here have provided seminal insights into the effective operation of MGs and have contributed to a growing interest in improving MGs performance. These references are categorized in Table 3 according to the methodologies. Also, the studies were classified different aspects in terms of main problem, purpose and methodology in Table 4. On the other hand, supervisory controllers and EMS for MGs including control targets, decision-making strategies and their solution methods were reviewed in detail in [146–148]. A basic structure including production and consumption components in EMS is shown in Figure 7 [149].

**Table 3.** Methodologies used in studies.

Methodology	Literature studies
Learning-based algorithms	[106], [114], [118], [124], [135], [136]
Heuristic algorithms	[105], [108], [109], [114], [128], [130], [131], [132], [133], [144], [145]
Control algorithm based methods	[101], [104], [108], [112], [113], [133], [138], [141], [150]
Mixed integer-based algorithms	[111], [114], [115], [116], [129], [139], [142], [143]
Classification-based methods	[37]
Game theory-based models	[107]
Stochastic programming	[103], [116], [126], [137]
Two-stage robust optimization	[121]
Dynamic programming	[113], [117], [123], [140]
Others	[100], [102], [110], [120], [122], [125], [127], [131], [133], [151], [152], [153], [154]

Table 4. Features of EMS-based studies.

EMS basis	Methodology	Main problem	Purpose	On-grid	Ref.	Year of pub.
Cost optimization	Unit commitment	Reducing the fuel consumption rate of the system while constraining it to fulfil the local energy demand (both electrical and thermal) and provide a certain minimum reserve power	Minimization of fuel use in a microgrid with a variety of power source	Yes	[58]	2005
Stability-constrained droop control of inverters	Droop stability analysis, droop selection, and generator dispatch optimization	Frequency-droop effects on stability in MG	Minimize fuel consumption and also ensures stable operation	No	[59]	2008
MG in grid-connected and stand-alone modes	Double-layer coordinated control	Reliability of power supply and economic benefits	Obtaining an economic operation scheme based on forecasting data and providing power of controllable units based on real-time data	Yes	[60]	2013
Power sharing between batteries and ultracapacitor	Dual active bridge converter control	Intermittent nature of RESs and , quick fluctuation of load demands	Actively distribute the power demand among the different energystorages	Yes	[61]	2011
Optimization-based, traditional gradient-based techniques	PSO and ACO	Power management	Minimize environmental emissions and minimize the cost of generation	No	[62]	2010
Dynamic security model	Offline analysis, online calculations and real-time protection	RES-based MGs becoming more susceptible to incipient faults with the low inertia.	MG security	Yes	[93]	2017
Fault detection and faulted section identification	The frequency and associated transient power of the first cycle of the oscillation	The service reliability and the power quality	Faulted section isolation	Yes	[96]	2018

Table 4. (Continued).

EMS basis	Methodology	Main problem	Purpose	On-grid	Ref.	Year of pub.
Fault detection	A new fault detection method based on the phase differences between the positive-sequence fault component of the bus voltage and the positive-sequence fault components of the currents in the feeders	High-impedance faults and low-impedance faults	Analyzing the fault component characteristics of a MG	Yes	[97]	2018
Heuristic algorithms	Particle swarm optimization, Gaussian mutation	The capital investment and fuel costs of the system	Maximizing the contribution of renewable sources in energy supply	No	[130]	2016
	Niching evolutionary algorithm	Optimal dispatching of local resources	Minimizing the overall microgrid operating cost and the pollutants emission of the programmable generators	No	[131]	2012
	Gray wolf optimization	Demand and generation uncertainties	Minimizing the expected operational cost, the pollutants emission cost, cost of power losses as well as energy not supplied of the microgrids while accommodating the intermittent nature of load consumption and renewable power generation	No	[132]	2017

Table 4. (Continued).

EMS basis	Methodology	Main problem	Purpose	On-grid	Ref.	Year of pub.
Heuristic algorithms	Neural network ensemble, fuzzy logic, short-term forecasting	Prediction 24 hour ahead photovoltaic generation, one hour aheadwind power generation and load demand, battery scheduling process	Minimizing the operation cost and the environmental impact of a MG	Yes	[133]	2013
	Nonintrusive load monitoring, recurrent neural network, deep learning	Analyzing energy consumption behaviors of the end-users	Minimizing operation costs, maximizing comfort level	Yes	[144]	2020
Control algorithm based methods	Unit commitment	Economic evaluation of a typical microgrid participating in a real-time market following different policies	Optimizing the production of the local DGs and power exchanges with the main distribution grid	Yes	[141]	2008
	Mixed integer probleming	Basic unit commitment issues	Minimizing operational costs	No	[139]	2012
Optimization-based	MILP	Surplus, Shortage and Adjustable Power	Minimizing the total operational cost of each microgrid	Yes	[142]	2018
		Intermittent nature of renewable generation, MG flexibility	Minimizing the total cost, by optimizing DER schedules	No	[143]	2013

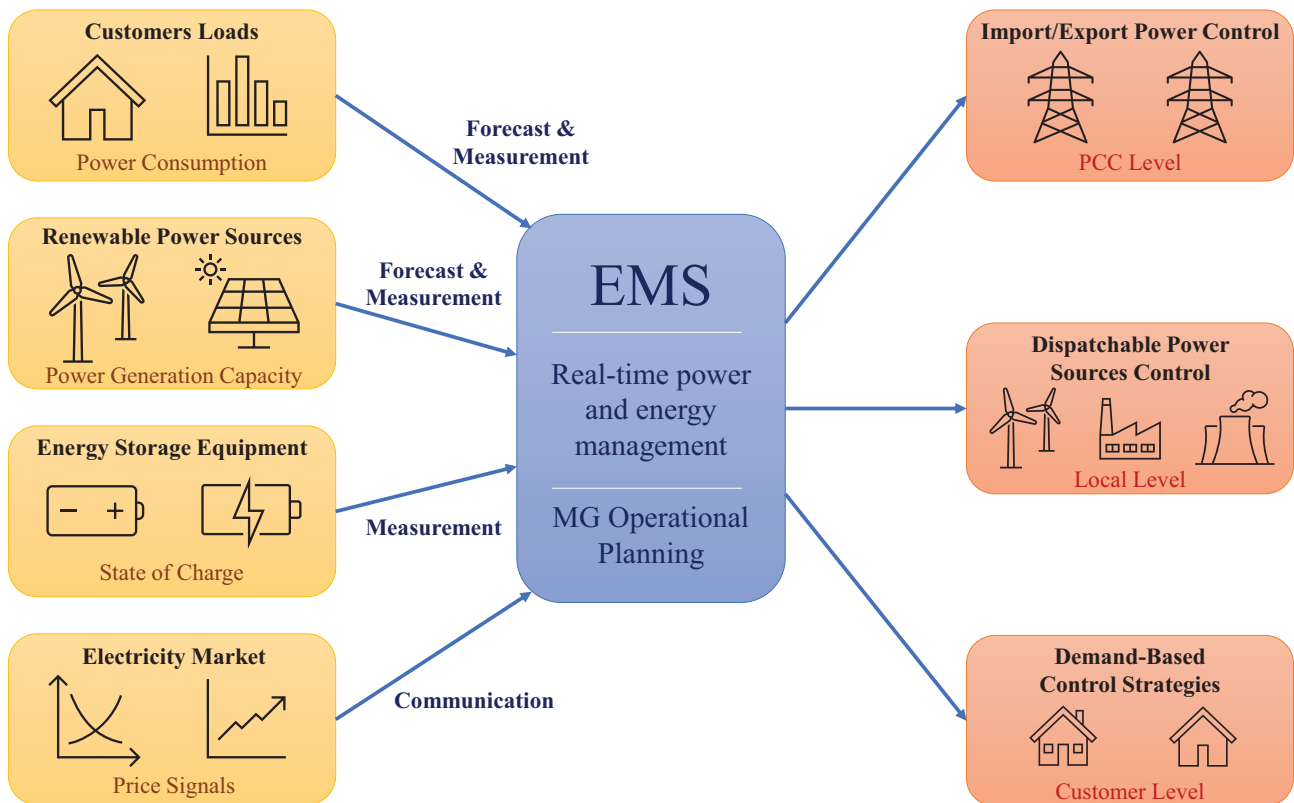

Figure 7. Energy management systems adopted from [149].

#### 4.4. Networked microgrid concept

Another important widely-known implementation is that networked, namely, NMG structure. This concept was presented with greater efforts to enhance resiliency, reliability and to reduce total investment and operational costs while improving efficiency. The basic NMG structure is shown in Figure 8. There are significant amount of literature studies that recognizes the importance of coordinating multi-MG (MMG) into the utility grid. In this regard, a new hybrid market mechanism including pool emergency transactions and bilateral contracts was proposed in [155] which enables to coordinate mentioned transactions with the target of reducing the risk factor of the RES-based MMG energy system. An agent based hierarchical multiobjective decision strategy for dealing with the power management challenges of the energy network was introduced in [156]. With performing the Nash Bargaining Solution approach, each MG aims to obtain Pareto-optimal solution for theirs power management problem in the lower level and utility company gets involved on this process to reach its own targets in the highest level.

A fully distributed model-predictive and computational-intelligence based algorithm for achieving autonomous and optimal operation of smart MMG was developed in [157]. It enabled to improve management strategies for scheduling internal equipments holistically as well as external energy trading process.

In order to deal with rapid load changes, a multiagent-based energy market model for MMG systems was developed in [158]. This framework tried to minimize power mismatch in and among MGs thanks to game-theoretic and fast optimization algorithm.

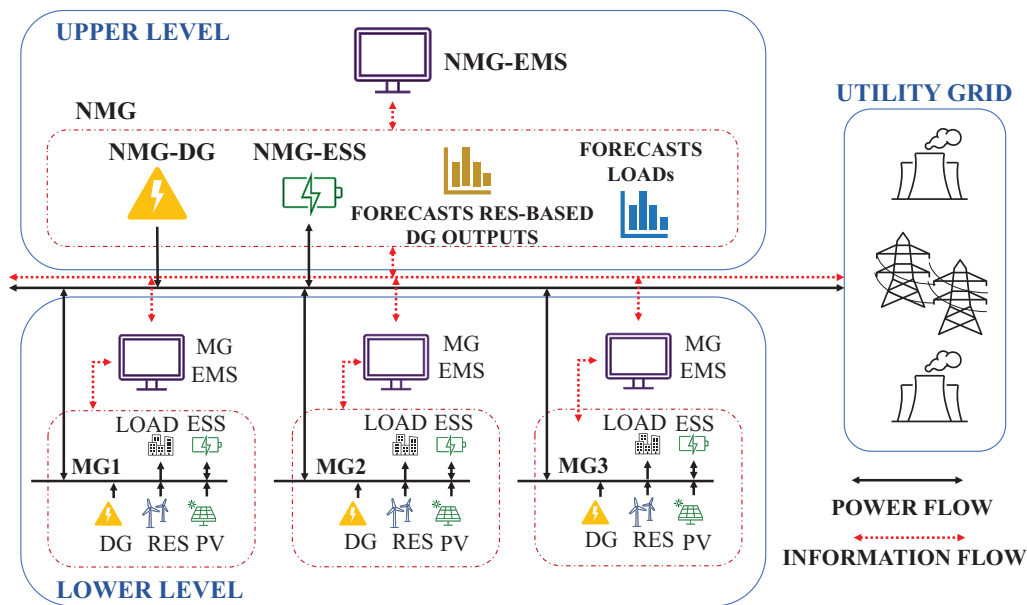

Figure 8. The basic NMG structure.

Also in [159], a distributed robust energy management framework was proposed for MMG system in order to provide optimal operation of MG aims to minimize total cost consisting of fuel cost of DGs, energy exchange related costs and battery ESS degradation cost in real-time energy market. The uncertain nature of RES, various load demand and volatile electricity prices were taken into consideration for making a realistic approach. Additionally, the authors in [160] developed a distributed-based power management scheme with the goal of minimizing total generating cost by taking into account the constraints such as the ramp-rate constraint, the capacity constraint and other like. Moreover, a new robust control technique was introduced in [161] for islanded multiple DG based MG in which all DGs interconnected with their load via a voltage-source converter, a series RL filter and a step-up transformer. In addition, a fuzzy-based power exchange management was developed in [148] for two adjacent residential grid connected MGs which capable of trading energy with each other thanks to PV and BESS. It has been deduced that injected power from the main grid was reduced substantially and synchronized BESS operation was achieved.

From the power system operator's view, optimal coordination of MGs makes several noteworthy contributions especially considering the ever-increasing demand, expected highest power quality of services as well as reliability issues. In this context, a two-level control methodology concentrates on the investigation of improving optimal energy management strategy for NMGs with facilitating the operated in islanded mode in [162]. The authors in [163] presented a comprehensive modeling, analysis, and stabilization method for PV-based MMG clusters. It is stated that this was the first study of substantial duration which analyses dynamic behavior of PV sources and DC links aims to fill the gap and enhance the power system operational effectiveness.

To tackle the operational challenges of NMGs, primary frequency control method was proposed in [164], a hierarchical distributed energy management strategy with energy routing was presented in [165], demand response program investigation was reported in [166], a distributed multienergy management framework was developed in [167], a dynamic equivalent modeling method for the inverter-based MMG was examined in [168] while real-time supervisory control algorithm was proposed in [169].



Cheng et al. propounded an emission-aware MG cluster energy management model to maximize the social welfare of the entire cluster [170]. Emission-aware trade preference coefficient has been introduced in modeling incremental benefits and costs to accurately reflect each MG's service choices. The distributed trading mechanism set up to decentralize each MG's energy management decisions also addresses privacy concerns that arise in the traditional centralized model.

Depending on the development of data science in estimation systems, data-based methods have started to be used for MMG applications. An smart MMG energy management method has been introduced in [171] based on deep neural network and model-free reinforcement learning techniques. According to the under considered problem, MMGs were connected to the main distribution system and buy power from the distribution system to meet local demand. However, the objectives of the distribution system operator (DSO) were reducing the demand-side peak-to-average ratio (PAR) and maximizing the profit from sold energy.

Additionally in [172], a structure for privacy and security extension of power trading in the NMGs based on the blockchain-enabled IoT model was proposed. A new unscented transform-based stochastic system has been developed to model the uncertainties of RES and the hourly load profile. A NMG structure with noncrucial, intermediate level and crucial loads was used to test the performance of the proposed framework.

#### 4.5. Resiliency-based microgrid applications

The occurrence rate of large-scale weather events and natural disasters are increasing with global warming according to the statistical data [173]. These extreme events can cause great damages to critical infrastructure lifeline systems particularly electrical bulk power grid which is one of the most critical, yet vulnerable infrastructure. Therefore, the emerging concept of resiliency focus on decreasing the impacts of "high-impact, low-frequency" events for ensuring the continued supply of electricity when existing grid infrastructure fully or partially disabled. MGs have been instrumental in such occasions and could play a key role with operating DERs as grid-support services to mitigate negative consequences of extraordinary events in the smart grid paradigm [174]. The MG structure to be developed for grid-resiliency includes critical load facilities such as emergency operations center, city hall, police, fire, hospitals, data centers and military. However, local load management systems, being able to automatically disconnect from the grid and switch off "island mode", compatible with local utilities, automation of MG circuits and loads are the key elements of the "self-healing" framework to be provided by MGs and DGs [175]. The resiliency-based developed MG structure includes critical load facilities such as emergency operations center, city hall, police, fire brigade, hospitals, data centers and military.

In order to detail the role of MGs in boosting power system resiliency, a broad spectrum of researchers has been performed studies in the literature from different points of view. Among them, the feasibility, benefits and technical challenges of using MGs as resiliency resources have been evaluated in [176] within the flexibility schemes. Three specific configurations were defined which using as community resource, local resource, and as a black start resource. A process of developing operator nomograms has been introduced to support real-time operations during extreme weather conditions. Xu et al. [177] conducted a study for comparing the level of power system resiliency with and without MG integration in a scenario-based analysis. It should be highlighted that the number of switching operations and the restoration time were substantially reduced while demanded power of loads was matched more during the extreme situations.

Abdubannaev et al. [178] introduced the effects of MG on the distribution system. Two case studies have been established for disconnected and NMGs and the effects of different topologies on distribution network resiliency have been examined. It has been observed that the NMGs provide secure and reliable operation by

more efficiently compensating the uncertain power output caused by the RES.

Load recovery process is formed by (1) failure isolation, (2) preliminary load recovery and (3) optimal MG formation steps. The decentralized load restoration model which serves critical loads can be developed by obtaining MMGs energized by DGs [179]. For instance in [180], a novel comprehensive operation and self-healing strategy was proposed. According to the optimization model, it was aimed to minimize costs and maximize revenues while in normal operating mode. A rolling-horizon optimization method was used to schedule dispatchable DGs. In self-healing mode, the distribution system was divided into self-supplied MGs so that the maximum load can be fed. DGs output power and consumption were modeled as a stochastic program. Also in [181], in order to restore critical loads using DGs and automatic remotely controlled switches in face of grid-scale failures, a real-time application with forming MGs was proposed.

Sezdro et al. [182] presented an optimization-based framework in optimal MG formation concept. Unlike the studies considering only unidirectional power flows, bidirectional power flow with high penetration of RESs was taken into account in developed scheme. In addition, incorporation of both mobile and fixed DGs as well as demand responsive loads were the issue.

Reference [183] focused on MG formations around DERs in an optimal fashion aftermath of the event in which capacity and fuel availability constraints were taken into account in nonlinear mixed integer programming model.

Khederzadeh and Zandi [184] propounded a sophisticated solution based on combination of reconfiguration and application of MG to improve the restoration capacity of distribution system using spanning tree search strategy. The presented structure aimed to utilize MG as a backup source when main power grid was unavailable to serve particularly critical loads as much as possible. Minimizing the number of switching operations, total system losses and out-of-service loads were determined as objectives of the study. The authors in [185] proposed a modified Viterbi algorithm-based distribution system restoration strategy aiming to maximize load recovery with least number of switching pairs operations. Furthermore, the impacts of integrating available DERs and MGs in the presented architecture were investigated in detail in terms of resilience enhancement performances. Same as [186], also in [187], a graph-theoretic restoration algorithm was developed for improving resiliency of the system aftermath of the event. Similarly, critical load restoration strategy was taken under study in MG concept considering both the uncertain nature of intermittent resources and loads [188].

From different perspective, Borghei et al. [186] developed a computational efficient algorithm for optimal sizing and siting of MGs as well as performing appropriate switching operations in the need of supplying critical loads. The designed heuristic optimization method proposes the optimum installation location for MGs, as well as determines the appropriate capacities of generation units within MG.

The control of islanding operations and uncertainty conditions play an important role in the studies carried out under resiliency concept. Graph-theory based methods are used in [187, 189, 190] for operational transactions in emergency situations. Zhu et al. [189] developed an algorithm that takes into account the RES uncertainties and load fluctuations. The proposed algorithm allows dynamic MG formation during the recovery period and was analyzed by comparison with the existing static islanding model and intelligent algorithms. In [187], maximizing the restored load and minimizing the number of switching operations were targeted with the presented algorithms. The graph-theory-based approach developed to select the optimal MG topology was tested with simulation tools. Similarly, in [190], candidate MG structures were formed by evaluating all suitable connection possibilities between critical loads and DGs in order to maintain the feeding of critical loads at the time of extreme event.

The authors in [191] presented a graphical based algorithm for local power restoration using MG. The created algorithm has tested for single and multiple faults in the system. Case studies have been coordinated with MG frameworks which contain complete restoration, MG load sharing and partial restoration serving with and without critical nodes. The resiliency strategies of the aforementioned references are summarized in Table 5. Also in Table 6, the chronological development of the characteristic features of MG concepts is summarized.

**Table 5.** Classification of resiliency-driven strategies in the literature.

Strategies	Classification	References
Planning strategies	Preventive allocation	[181], [182], [186], [192]
	Optimal sizing	[186], [192]
Operational strategies	DG islanding	[178], [179], [181]
	DR	[182]
	Feasible islanding	[188], [191]
	Reconfiguration	[176], [183], [184], [185], [187], [193]
	Vulnerability analysis	[177]

**Table 6.** The changes in MG operation from maturity to the future: a timeline.

Characteristic	In the beginning (1880s)	First part of 20th century	Second part of 20th century	Early 2000s to future
Main aim	For illuminating	Industrial facilities and remote areas	Industrial facilities and remote area	Increase renewable energy use, improve resiliency
Standardized	No standard for a generation-distribution system	Standardize voltage, frequency etc.	Standardized equipment	Standardized communications and data interchange protocols
Control	-	Electromechanical	SCADA applications	EMS, DMS, part of grid-wise hierarchical control, market constraints
Operation philosophy	Island mode operation	Island mode operation	Island mode operation, emergency supply system	Interconnected, networked and island mode operation capability
Voltage type	DC	AC	AC	AC and DC
Generation philosophy	Mainly based on fossil fuel	Mainly based on fossil fuel	Mainly based on fossil fuel	Mainly based on renewable sources, and storage units
Efficiency	Early application on CHP, not main objective	Not main objective	Not main objective	Main objective
EMS architectures	Single generation unit	Coordinated generation units	Coordinated generation units	Market driven production and consumption

As a consequence, it becomes starkly apparent that MG architecture is currently the most widely accepted option to provide energy to the end-users when considering changing the structure of the power system. Hence, in this comprehensive literature survey, since the emergence of this concept, the main purpose of MG integration, presented promising approaches to tackle the barriers and challenges as well as incorporated innovative technologies and concepts have been investigated with a growing body of literature. The objective of the work presented in this article is to shine new light on the transformed structure of MG from past to the present in terms of its characteristics (main aim, control strategies, operation and generation philosophy) with comprehensive and systematic fashion. These all would pave the way for researchers to understand over- and underinvestigated concepts, methodologies and the requirements when taking full advantage of MG architecture.

## 5. Concluding remarks

The MG framework presents a great deal of opportunities from the system operator's view. In this study, the concept of MG is investigated from traditional structure to future with comprehensive literature studies. To address the integration challenges of MG, PE interface components present great deal of benefits in terms of regulating voltage, achieving reactive power control and providing flexible operation. In this respect, conducted literature studies are reviewed for traditional architecture and dominated RESs MG schemes. Additionally, optimal operational concerns have been widely investigated to cope with sophisticated structure of MG and management strategies are considered for both traditional and modern MGs from different aspects. Finally, comprehensive investigation is performed for modern power system with systematically reviews the ESS option, DSM strategies, EMS techniques, NMG concept and resiliency-based MG applications. It should be highlighted that recent studies have focused on modern structures and applications considering great transformations in the traditional architecture of power system as well as MGs. The main challenges i.e. stability, power quality and reliability, draw significant attention from a broad number of actors in the literature. Also, with increasing rate of climatic issues and weather-based events pave the way for incorporating MG architectures as a grid-support service. Considerable amount of researches were reviewed in systematic fashion from the wider perspective for focusing on resilience enhancement strategies.

## References

- [1] Parhizi S, Lotfi H, Khodaei A, Bahramirad S. State of the art in research on microgrids: a review. *IEEE Access* 2015; 3: 890-925. doi: 10.1109/ACCESS.2015.2443119
- [2] Ton DT, Smith MA. The U.S. Department of Energy's microgrid initiative. *The Electricity Journal* 2012; 25 (8): 84-94. doi: 10.1016/j.tej.2012.09.013
- [3] Marnay C, Chatzivasileiadis S, Abbey C, Iravani R, Joos G et al. Microgrid evolution roadmap. In: 2015 International Symposium on Smart Electric Distribution Systems and Technologies (EDST); Vienna, Austria; 2015. pp. 139-144.
- [4] Komala K, Kumar KP, Cherukuri SHC. Storage and non-storage methods of power balancing to counter uncertainty in hybrid microgrids - a review. *Journal of Energy Storage* 2021; 36: 102348. doi: 10.1016/j.est.2021.102348
- [5] Mohammed A, Refaat SS, Bayhan S, Abu-Rub H. AC microgrid control and management strategies: evaluation and review. *IEEE Power Electronics Magazine* 2019; 6 (2): 18-31. doi: 10.1109/MPEL.2019.2910292
- [6] Anderson AA, Suryanarayanan S. Review of energy management and planning of islanded microgrids. *CSEE Journal of Power and Energy Systems* 2020; 6 (2): 329-343. doi: 10.17775/CSEEJPES.2019.01080

- [7] Kroposki B, Basso T, DeBlasio R. Microgrid standards and technologies. In: 2008 IEEE Power and Energy Society General Meeting - Conversion and Delivery of Electrical Energy in the 21st Century; Pittsburgh, PA, USA; 2008. pp. 1-4.
- [8] Guerrero JM, Chandorkar M, Lee T, Loh PC. Advanced control architectures for intelligent microgrids—Part i: decentralized and hierarchical control. *IEEE Transactions on Industrial Electronics* 2013; 60 (4): 1254-1262. doi: 10.1109/TIE.2012.2194969
- [9] Olivares DE, Mehrizi-Sani A, Etemadi AH, Cañizares CA, Iravani R et al. Trends in microgrid control. *IEEE Transactions on Smart Grid* 2014; 5 (4): 1905-1919. doi: 10.1109/TSG.2013.2295514
- [10] Guerrero JM, Loh PC, Lee T, Chandorkar M. Advanced control architectures for intelligent microgrids—Part ii: power quality, energy storage, and ac/dc microgrids. *IEEE Transactions on Industrial Electronics* 2013; 60 (4): 1263-1270. doi: 10.1109/TIE.2012.2196889
- [11] Bidram A, Davoudi A. Hierarchical structure of microgrids control system. *IEEE Transactions on Smart Grid* 2012; 3 (4): 1963-1976. doi: 10.1109/TSG.2012.2197425
- [12] Dragičević T, Lu X, Vasquez JC, Guerrero JM. DC microgrids—Part i: a review of control strategies and stabilization techniques. *IEEE Transactions on Power Electronics* 2016; 31 (7): 4876-4891. doi: 10.1109/TPEL.2015.2478859
- [13] Cagnano A, De Tuglie E, Mancarella P. Microgrids: overview and guidelines for practical implementations and operation. *Applied Energy* 2020; 258: 114039. doi: 10.1016/j.apenergy.2019.114039
- [14] Han H, Hou X, Yang J, Wu J, Su M et al. Review of power sharing control strategies for islanding operation of ac microgrids. *IEEE Transactions on Smart Grid* 2016; 7 (1): 200-215. doi: 10.1109/TSG.2015.2434849
- [15] Yazdani M, Mehrizi-Sani A. Distributed control techniques in microgrids. *IEEE Transactions on Smart Grid* 2014; 5 (6): 2901-2909. doi: 10.1109/TSG.2014.2337838
- [16] Majumder R. Some aspects of stability in microgrids. *IEEE Transactions on Power Systems* 2013; 28 (3): 3243-3252. doi: 10.1109/TPWRS.2012.2234146
- [17] Colson CM, Nehrir MH. A review of challenges to real-time power management of microgrids. In: 2009 IEEE Power Energy Society General Meeting; Calgary, AB, Canada; 2009. pp. 1-8.
- [18] Alonso-Martínez J, Carrasco JE, Arnaltes S. Table-based direct power control: a critical review for microgrid applications. *IEEE Transactions on Power Electronics* 2010; 25 (12): 2949-2961. doi: 10.1109/TPEL.2010.2087039
- [19] Mahmoud MS, Rahman MSU, A.L.-Sunni FM. Review of microgrid architectures – a system of systems perspective. *IET Renewable Power Generation* 2015; 9 (8): 1064-1078. doi:10.1049/iet-rpg.2014.0171
- [20] Choudhary NK, Mohanty SR, Singh RK. A review on microgrid protection. In: 2014 International Electrical Engineering Congress (iEECON); Chonburi, Thailand; 2014. pp. 1–4.
- [21] Habib HF, Lashway CR, Mohammed OA. On the adaptive protection of microgrids: a review on how to mitigate cyber attacks and communication failures. In: 2017 IEEE Industry Applications Society Annual Meeting; Cincinnati, OH, USA; 2017. pp. 1-8.
- [22] Etxeberria A, Vechiu I, Camblong H, Vinassa JM, Camblong H. Hybrid energy storage systems for renewable energy sources integration in microgrids: a review. In: 2010 Conference Proceedings IPEC; Singapore; 2010. pp. 532-537.
- [23] Ravichandran A, Malysz P, Sirouspour S, Emadi A. The critical role of microgrids in transition to a smarter grid: A technical review. In: 2013 IEEE Transportation Electrification Conference and Expo (ITEC); Detroit, MI, USA; 2013. pp. 1-7.
- [24] Kulasekera AL, Gopura RARC, Hemapala KTMU, Perera N. A review on multi-agent systems in microgrid applications. In: ISGT2011-India; Kollam, India; 2011. pp. 173-177.
- [25] Mostafa HA, Shatshat RE, Salama MMA. A review on energy management systems. In: 2014 IEEE PES T D Conference and Exposition; Chicago, IL, USA; 2014. pp. 1-5.

- [26] Nanfang Yang, Paire D, Fei Gao, Miraoui A. Power management strategies for microgrid—a short review. In: 2013 IEEE Industry Applications Society Annual Meeting; Lake Buena Vista, FL, USA; 2013. pp. 1-9.
- [27] Samad T, Koch E, Stluka P. Automated demand response for smart buildings and microgrids: the state of the practice and research challenges. *Proceedings of the IEEE* 2016; 104 (4): 726-744. doi: 10.1109/JPROC.2016.2520639
- [28] Barnes M, Kondoh J, Asano H, Oyarzabal J, Ventakaramanan G et al. Real-world microgrids—an overview. In: 2007 IEEE International Conference on System of Systems Engineering; San Antonio, TX, USA; 2007. pp. 1-8.
- [29] Dragičević T, Lu X, Vasquez JC, Guerrero JM. DC microgrids—Part ii: a review of power architectures, applications, and standardization issues. *IEEE Transactions on Power Electronics* 2016; 31 (5): 3528-3549. doi: 10.1109/TPEL.2015.2464277
- [30] Hirsch A, Parag Y, Guerrero J. Microgrids: a review of technologies, key drivers, and outstanding issues. *Renewable and Sustainable Energy Reviews* 2018; 90 : 402-411. doi: 10.1016/j.rser.2018.03.040
- [31] Mariam L, Basu M, Conlon MF. Microgrid: architecture, policy and future trends. *Renewable and Sustainable Energy Reviews* 2016; 64: 477-489. doi: 10.1016/j.rser.2016.06.037
- [32] Oueid RK. Microgrid finance, revenue, and regulation considerations. *The Electricity Journal* 2019; 32 (5): 2-9. doi: 10.1016/j.tej.2019.05.006
- [33] De Souza ACZ, Castilla M (editors). *Microgrids Design and Implementation*. Cham, Switzerland: Springer International Publishing, 2019.
- [34] Bist N, Sircar A, Yadav K. Holistic review of hybrid renewable energy in circular economy for valorization and management. *Environmental Technology & Innovation* 2020; 20: 101054. doi: 10.1016/j.eti.2020.101054.
- [35] Meng L, Shafiee Q, Trecate GF, Karimi H, Fulwani D et al. Review on control of dc microgrids and multiple microgrid clusters. *IEEE Journal of Emerging and Selected Topics in Power Electronics* 2017; 5 (3): 928-948. doi: 10.1109/JESTPE.2017.2690219
- [36] Faisal M, Hannan MA, Ker PJ, Hussain A, Mansor MB et al. Review of energy storage system technologies in microgrid applications: issues and challenges. *IEEE Access* 2018; 6 : 35143-35164. doi: 10.1109/ACCESS.2018.2841407
- [37] Khodadoost Arani AA, Gharehpetian GB, Abedi M. Review on energy storage systems control methods in microgrids. *International Journal of Electrical Power & Energy Systems* 2019; 107: 745-757. doi: 10.1016/j.ijepes.2018.12.040
- [38] Mwasilu F, Justo JJ, Kim E-K, Do TD, Jung J-W. Electric vehicles and smart grid interaction: a review on vehicle to grid and renewable energy sources integration. *Renewable and Sustainable Energy Reviews* 2014; 34: 501-516. doi: 10.1016/j.rser.2014.03.031
- [39] Yong JY, Ramachandaramurthy VK, Tan KM, Mithulananthan N. A review on the state-of-the-art technologies of electric vehicle, its impacts and prospects. *Renewable and Sustainable Energy Reviews* 2015; 49: 365-385. doi: 10.1016/j.rser.2015.04.130
- [40] Nosratabadi SM, Hooshmand R-A, Gholipour E. A comprehensive review on microgrid and virtual power plant concepts employed for distributed energy resources scheduling in power systems. *Renewable and Sustainable Energy Reviews* 2017; 67: 341-363. doi: 10.1016/j.rser.2016.09.025
- [41] Lasseter B. Microgrids [distributed power generation]. In: 2001 IEEE Power Engineering Society Winter Meeting. Conference Proceedings (Cat. No.01CH37194); Columbus, OH, USA; 2001. pp. 146-149.
- [42] Xu Y, Sun H, Gu W, Xu Y, Li Z. Optimal distributed control for secondary frequency and voltage regulation in an islanded microgrid. *IEEE Transactions on Industrial Informatics* 2019; 15 (1): 225-235. doi: 10.1109/TII.2018.2795584
- [43] Cai H, Hu G. Distributed robust hierarchical power sharing control of grid-connected spatially concentrated ac microgrid. *IEEE Transactions on Control Systems Technology* 2019; 27 (3): 1012-1022. doi: 10.1109/TCST.2017.2789182

- [44] Delghavi MB, Yazdani A. Sliding-mode control of ac voltages and currents of dispatchable distributed energy resources in master-slave-organized inverter-based microgrids. *IEEE Transactions on Smart Grid* 2019; 10 (1): 980-991. doi: 10.1109/TSG.2017.2756935
- [45] Sahoo S, Mishra S. A distributed finite-time secondary average voltage regulation and current sharing controller for dc microgrids. *IEEE Transactions on Smart Grid* 2019; 10 (1): 282-292. doi: 10.1109/TSG.2017.2737938
- [46] Wang K, Yuan X, Geng Y, Wu X. A practical structure and control for reactive power sharing in microgrid. *IEEE Transactions on Smart Grid* 2019; 10 (2): 1880-1888. doi: 10.1109/TSG.2017.2779846
- [47] Diaz G, Gonzalez-Moran C, Gomez-Aleixandre J, Diez A. Scheduling of droop coefficients for frequency and voltage regulation in isolated microgrids. *IEEE Transactions on Power Systems* 2010; 25 (1): 489-496. doi: 10.1109/TPWRS.2009.2030425
- [48] Guerrero JM, Vasquez JC, Matas J, Vicuna LG de, Castilla M. Hierarchical control of droop-controlled ac and dc microgrids—a general approach toward standardization. *IEEE Transactions on Industrial Electronics* 2011; 58 (1): 158-172. doi: 10.1109/TIE.2010.2066534
- [49] Yunwei Li, Vilathgamuwa DM, Poh Chiang Loh. Design, analysis, and real-time testing of a controller for multibus microgrid system. *IEEE Transactions on Power Electronics* 2004; 19 (5): 1195-1204. doi: 10.1109/TPEL.2004.833456
- [50] Kroposki B, Pink C, DeBlasio R, Thomas H, Simões M et al. Benefits of power electronic interfaces for distributed energy systems. *IEEE Transactions on Energy Conversion* 2010; 25 (3): 901-908. doi: 10.1109/TEC.2010.2053975
- [51] Yunwei Li, Vilathgamuwa DM, Poh Chiang Loh. Microgrid power quality enhancement using a three-phase four-wire grid-interfacing compensator. *IEEE Transactions on Industry Applications* 2005; 41 (6): 1707-1719. doi: 10.1109/TIA.2005.858262
- [52] Chakraborty S, Simoes MG. Advanced active filtering in a single phase high frequency ac microgrid. In: 2005 IEEE 36th Power Electronics Specialists Conference; Dresden, Germany; 2005. pp. 191-197.
- [53] Weiss G, Qing-Chang Zhong, Green TC, Jun Liang. H/sup /spl infin// repetitive control of dc-ac converters in microgrids. *IEEE Transactions on Power Electronics* 2004; 19 (1): 219-230. doi: 10.1109/TPEL.2003.820561
- [54] Katiraei F, Irvani MR, Lehn PW. Micro-grid autonomous operation during and subsequent to islanding process. *IEEE Transactions on Power Delivery* 2005; 20 (1): 248-257. doi: 10.1109/TPWRD.2004.835051
- [55] Macken KJP, Bollen MHJ, Belmans RJM. Mitigation of voltage dips through distributed generation systems. *IEEE Transactions on Industry Applications* 2004; 40 (6): 1686-1693. doi: 10.1109/TIA.2004.836302
- [56] Nikkhajoei H, Irvani R. Steady-state model and power flow analysis of electronically-coupled distributed resource units. *IEEE Transactions on Power Delivery* 2007; 22 (1): 721-728. doi: 10.1109/TPWRD.2006.881604
- [57] Biczal P. Power electronic converters in dc microgrid. In: 2007 Compatibility in Power Electronics; Gdansk, Poland; 2007. pp. 1-6.
- [58] Hernandez-Aramburo CA, Green TC, Mugniot N. Fuel consumption minimization of a microgrid. *IEEE Transactions on Industry Applications* 2005; 41 (3): 673-681. doi: 10.1109/TIA.2005.847277
- [59] Barklund E, Pogaku N, Prodanovic M, Hernandez-Aramburo C, Green TC. Energy management in autonomous microgrid using stability-constrained droop control of inverters. *IEEE Transactions on Power Electronics* 2008; 23 (5): 2346-2352. doi: 10.1109/TPEL.2008.2001910
- [60] Jiang Q, Xue M, Geng G. Energy management of microgrid in grid-connected and stand-alone modes. *IEEE Transactions on Power Systems* 2013; 28 (3): 3380-3389. doi: 10.1109/TPWRS.2013.2244104
- [61] Zhou H, Bhattacharya T, Tran D, Siew TST, Khambadkone AM. Composite energy storage system involving battery and ultracapacitor with dynamic energy management in microgrid applications. *IEEE Transactions on Power Electronics* 2011; 26 (3): 923-930. doi: 10.1109/TPEL.2010.2095040
- [62] Colson CM, Nehrir MH, Pourmousavi SA. Towards real-time microgrid power management using computational intelligence methods. In: IEEE PES General Meeting; Minneapolis, MN, USA; 2010. pp. 1-8.

- [63] Yingyuan Zhang, Meiqin Mao, Ming Ding, Liuchen Chang. Study of energy management system for distributed generation systems. In: 2008 Third International Conference on Electric Utility Deregulation and Restructuring and Power Technologies; Nanjing, China; 2008. pp. 2465-2469.
- [64] Kleftakis V, Lagos D, Papadimitriou C, Hatziaargyriou ND. Seamless transition between interconnected and islanded operation of dc microgrids. *IEEE Transactions on Smart Grid* 2019; 10 (1): 248-256. doi: 10.1109/TSG.2017.2737595
- [65] Mi Y, Zhang H, Fu Y, Wang C, Loh PC et al. Intelligent power sharing of dc isolated microgrid based on fuzzy sliding mode droop control. *IEEE Transactions on Smart Grid* 2019; 10 (3): 2396-2406. doi: 10.1109/TSG.2018.2797127
- [66] Hans CA, Braun P, Raisch J, Grüne L, Reincke-Collon C. Hierarchical distributed model predictive control of interconnected microgrids. *IEEE Transactions on Sustainable Energy* 2019; 10 (1): 407-416. doi: 10.1109/TSSTE.2018.2802922
- [67] Deng Z, Xu Y, Sun H, Shen X. Distributed, bounded and finite-time convergence secondary frequency control in an autonomous microgrid. *IEEE Transactions on Smart Grid* 2019; 10 (3): 2776-2788. doi: 10.1109/TSG.2018.2810287
- [68] Xu Y, Guo Q, Sun H, Fei Z. Distributed discrete robust secondary cooperative control for islanded microgrids. *IEEE Transactions on Smart Grid* 2019; 10 (4): 3620-3629. doi: 10.1109/TSG.2018.2833100
- [69] Dehnavi G, Ginn HL. Distributed load sharing among converters in an autonomous microgrid including pv and wind power units. *IEEE Transactions on Smart Grid* 2019; 10 (4): 4289-4298. doi: 10.1109/TSG.2018.2856480
- [70] Xia Y, Yu M, Yang P, Peng Y, Wei W. Generation-storage coordination for islanded dc microgrids dominated by pv generators. *IEEE Transactions on Energy Conversion* 2019; 34 (1): 130-138. doi: 10.1109/TEC.2018.2860247
- [71] Chauhan PJ, Reddy BD, Bhandari S, Panda SK. Battery energy storage for seamless transitions of wind generator in standalone microgrid. *IEEE Transactions on Industry Applications* 2019; 55 (1): 69-77. doi: 10.1109/TIA.2018.2863662
- [72] Ahmad J, Tahir M, Mazumder SK. Dynamic economic dispatch and transient control of distributed generators in a microgrid. *IEEE Systems Journal* 2019; 13 (1): 802-812. doi: 10.1109/JSYST.2018.2859755
- [73] Duan J, Wang C, Xu H, Liu W, Xue Y et al. Distributed control of inverter-interfaced microgrids based on consensus algorithm with improved transient performance. *IEEE Transactions on Smart Grid* 2019; 10 (2): 1303-1312. doi: 10.1109/TSG.2017.2762601
- [74] Roy TK, Mahmud MA. Dynamic stability analysis of hybrid islanded dc microgrids using a nonlinear backstepping approach. *IEEE Systems Journal* 2018; 12 (4): 3120-3130. doi: 10.1109/JSYST.2017.2769692
- [75] Chen G, Guo Z. Distributed secondary and optimal active power sharing control for islanded microgrids with communication delays. *IEEE Transactions on Smart Grid* 2019; 10 (2): 2002-2014. doi: 10.1109/TSG.2017.2785811
- [76] Ullah S, Khan L, Badar R, Ullah A, Karam FW et al. Consensus based soc trajectory tracking control design for economic-dispatched distributed battery energy storage system. *PLOS ONE* 2020; 15 (5): e0232638. doi: 10.1371/journal.pone.0232638
- [77] Ullah S, Khan L, Sami I, Ullah N. Consensus-based delay-tolerant distributed secondary control strategy for droop controlled ac microgrids. *IEEE Access* 2021; 9: 6033-6049. doi: 10.1109/ACCESS.2020.3048723
- [78] Bose U, Chattopadhyay SK, Chakraborty C, Pal B. A novel method of frequency regulation in microgrid. In: 2016 IEEE 7th Power India International Conference (PIICON); Bikaner, India; 2016. pp. 1-6.
- [79] Zhao-xia X, Mingke Z, Yu H, Guerrero JM, Vasquez JC. Coordinated primary and secondary frequency support between microgrid and weak grid. *IEEE Transactions on Sustainable Energy* 2019; 10 (4): 1718-1730. doi: 10.1109/TSSTE.2018.2869904
- [80] Iovine A, Carrizosa MJ, Damm G, Alou P. Nonlinear control for dc microgrids enabling efficient renewable power integration and ancillary services for ac grids. *IEEE Transactions on Power Systems* 2019; 34 (6): 5136-5146. doi: 10.1109/TPWRS.2018.2871369



- [81] Baghaee HR, Mirsalim M, Gharehpetian GB, Talebi HA. A decentralized power management and sliding mode control strategy for hybrid ac/dc microgrids including renewable energy resources. *IEEE Transactions on Industrial Informatics* 2017. doi: 10.1109/TII.2017.2677943
- [82] Baghaee HR, Mirsalim M, Gharehpetian GB, Talebi HA. Decentralized sliding mode control of wg/pv/fc microgrids under unbalanced and nonlinear load conditions for on- and off-grid modes. *IEEE Systems Journal* 2018; 12 (4): 3108-3119. doi: 10.1109/JSYST.2017.2761792
- [83] Han Y, Li H, Shen P, Coelho EAA, Guerrero JM. Review of active and reactive power sharing strategies in hierarchical controlled microgrids. *IEEE Transactions on Power Electronics* 2017; 32 (3): 2427-2451. doi: 10.1109/TPEL.2016.2569597
- [84] Rezkallah M, Chandra A, Singh B, Singh S. Microgrid: configurations, control and applications. *IEEE Transactions on Smart Grid* 2019; 10 (2): 1290-1302. doi: 10.1109/TSG.2017.2762349
- [85] Yallamilli RS, Mishra MK. Instantaneous symmetrical component theory based parallel grid side converter control strategy for microgrid power management. *IEEE Transactions on Sustainable Energy* 2019; 10 (2): 682-692. doi: 10.1109/TSSTE.2018.2845469
- [86] Vazquez N, Yu SS, Chau TK, Fernando T, Ju HH. A fully decentralized adaptive droop optimization strategy for power loss minimization in microgrids with pv-bess. *IEEE Transactions on Energy Conversion* 2019; 34 (1): 385-395. doi: 10.1109/TEC.2018.2878246
- [87] Baranwal M, Askarian A, Salapaka S, Salapaka M. A distributed architecture for robust and optimal control of dc microgrids. *IEEE Transactions on Industrial Electronics* 2019; 66 (4): 3082-3092. doi: 10.1109/TIE.2018.2840506
- [88] Zhao X, Chen C, Lai J. A high-efficiency active-boost-rectifier-based converter with a novel double-pulse duty cycle modulation for pv to dc microgrid applications. *IEEE Transactions on Power Electronics* 2019; 34 (8): 7462-7473. doi: 10.1109/TPEL.2018.2878225
- [89] Tu C, Xiao F, Lan Z, Guo Q, Shuai Z. Analysis and control of a novel modular-based energy router for dc microgrid cluster. *IEEE Journal of Emerging and Selected Topics in Power Electronics* 2019; 7 (1): 331-342. doi: 10.1109/JESTPE.2018.2878004
- [90] Jia H, Xiao Q, He J. An improved grid current and dc capacitor voltage balancing method for three-terminal hybrid ac/dc microgrid. *IEEE Transactions on Smart Grid* 2019; 10 (6): 5876-5888. doi: 10.1109/TSG.2018.2834340
- [91] Vuyyuru U, Maiti S, Chakraborty C, Pal BC. A series voltage regulator for the radial dc microgrid. *IEEE Transactions on Sustainable Energy* 2019; 10 (1): 127-136. doi: 10.1109/TSSTE.2018.2828164.
- [92] Adly M, Strunz K. Efficient digital control for mpp tracking and output voltage regulation of partially shaded pv modules in dc bus and dc microgrid systems. *IEEE Transactions on Power Electronics* 2019; 34 (7): 6309-6319. doi: 10.1109/TPEL.2018.2873753
- [93] Teimourzadeh S, Aminifar F, Davarpanah M, Shahidehpour M. Adaptive protection for preserving microgrid security. *IEEE Transactions on Smart Grid* 2019; 10 (1): 592-600. doi: 10.1109/TSG.2017.2749301.
- [94] Yu JJQ, Hou Y, Lam AYS, Li VOK. Intelligent fault detection scheme for microgrids with wavelet-based deep neural networks. *IEEE Transactions on Smart Grid* 2019; 10 (2): 1694-1703. doi: 10.1109/TSG.2017.2776310.
- [95] Soleimanisardoo A, Karegar HK, Zeineldin HH. Differential frequency protection scheme based on off-nominal frequency injections for inverter-based islanded microgrids. *IEEE Transactions on Smart Grid* 2019; 10 (2): 2107-2114. doi: 10.1109/TSG.2017.2788851
- [96] Mohanty R, Pradhan AK. DC ring bus microgrid protection using the oscillation frequency and transient power. *IEEE Systems Journal* 2019; 13 (1): 875-884. doi: 10.1109/JSYST.2018.2837748
- [97] Zhang F, Mu L. A fault detection method of microgrids with grid-connected inverter interfaced distributed generators based on the pq control strategy. *IEEE Transactions on Smart Grid* 2019; 10 (5): 4816-4826. doi: 10.1109/TSG.2018.2868967

- [98] Zhang Z, Chen Q, Xie R, Sun K. The fault analysis of pv cable fault in dc microgrids. *IEEE Transactions on Energy Conversion* 2019; 34 (1): 486-496. doi: 10.1109/TEC.2018.2876669
- [99] Lakshminarayanan V, Chemudupati VGS, Pramanick SK, Rajashekara K. Real-time optimal energy management controller for electric vehicle integration in workplace microgrid. *IEEE Transactions on Transportation Electrification* 2019; 5 (1): 174-185. doi: 10.1109/TTE.2018.2869469
- [100] Derakhshandeh SY, Ghiasian A, Masoum MAS. A new time-decoupled framework for pevs charging and scheduling in industrial microgrids. *IEEE Transactions on Smart Grid* 2019; 10 (1): 568-577. doi: 10.1109/TSG.2017.2748970
- [101] Zhong W, Xie K, Liu Y, Yang C, Xie S. Topology-aware vehicle-to-grid energy trading for active distribution systems. *IEEE Transactions on Smart Grid* 2019; 10 (2): 2137-2147. doi: 10.1109/TSG.2018.2789940
- [102] Li D, Yang Q, An D, Yu W, Yang X et al. On location privacy-preserving online double auction for electric vehicles in microgrids. *IEEE Internet of Things Journal* 2019; 6 (4): 5902-5915. doi: 10.1109/JIOT.2018.287244
- [103] Zhang Y, Yang Q, Yu W, An D, Li D et al. An online continuous progressive second price auction for electric vehicle charging. *IEEE Internet of Things Journal* 2019; 6 (2): 2907-2921. doi: 10.1109/JIOT.2018.2876422
- [104] Sbordone D, Bertini I, Di Pietra B, Falvo MC, Genovese A et al. EV fast charging stations and energy storage technologies: a real implementation in the smart micro grid paradigm. *Electric Power Systems Research* 2015; 120: 96-108. doi: 10.1016/j.epsr.2014.07.033
- [105] Chen C, Duan S. Optimal integration of plug-in hybrid electric vehicles in microgrids. *IEEE Transactions on Industrial Informatics* 2014; 10 (3): 1917-1926. doi: 10.1109/TII.2014.2322822
- [106] Li B, Chen T, Wang X, Giannakis GB. Real-time energy management in microgrids with reduced battery capacity requirements. *IEEE Transactions on Smart Grid* 2019; 10 (2): 1928-1938. doi: 10.1109/TSG.2017.2783894
- [107] Chiş A, Koivunen V. Coalitional game-based cost optimization of energy portfolio in smart grid communities. *IEEE Transactions on Smart Grid* 2019; 10 (2): 1960-1970. doi: 10.1109/TSG.2017.2784902
- [108] Zhao H, Hong M, Lin W, Loparo KA. Voltage and frequency regulation of microgrid with battery energy storage systems. *IEEE Transactions on Smart Grid* 2019; 10 (1): 414-424. doi: 10.1109/TSG.2017.2741668
- [109] Mu C, Zhang Y, Jia H, He H. Energy-storage-based intelligent frequency control of microgrid with stochastic model uncertainties. *IEEE Transactions on Smart Grid* 2020; 11 (2): 1748-1758. doi: 10.1109/TSG.2019.2942770
- [110] Li Y, He L, Liu F, Li C, Cao Y et al. Flexible voltage control strategy considering distributed energy storages for dc distribution network. *IEEE Transactions on Smart Grid* 2019; 10 (1): 163-172. doi: 10.1109/TSG.2017.2734166
- [111] Choi J, Shin Y, Choi M, Park W, Lee I. Robust control of a microgrid energy storage system using various approaches. *IEEE Transactions on Smart Grid* 2019; 10 (3): 2702-2712. doi: 10.1109/TSG.2018.2808914
- [112] Badwawi RA, Issa WR, Mallick TK, Abusara M. Supervisory control for power management of an islanded ac microgrid using a frequency signalling-based fuzzy logic controller. *IEEE Transactions on Sustainable Energy* 2019; 10 (1): 94-104. doi: 10.1109/TSTE.2018.2825655
- [113] Zhu Y, Zhao D, Li X, Wang D. Control-limited adaptive dynamic programming for multi-battery energy storage systems. *IEEE Transactions on Smart Grid* 2019; 10 (4): 4235-4244. doi: 10.1109/TSG.2018.2854300
- [114] Qin Y, Hua H, Cao J. Stochastic optimal control scheme for battery lifetime extension in islanded microgrid via a novel modeling approach. *IEEE Transactions on Smart Grid* 2019; 10 (4): 4467-4475. doi: 10.1109/TSG.2018.2861221
- [115] Yao S, Wang P, Zhao T. Transportable energy storage for more resilient distribution systems with multiple microgrids. *IEEE Transactions on Smart Grid* 2019; 10 (3): 3331-3341. doi: 10.1109/TSG.2018.2824820
- [116] Kim J, Dvorkin Y. Enhancing distribution system resilience with mobile energy storage and microgrids. *IEEE Transactions on Smart Grid* 2019; 10 (5): 4996-5006. doi: 10.1109/TSG.2018.2872521

- [117] Abdulgalil MA, Khalid M, Alshehri J. Microgrid reliability evaluation using distributed energy storage systems. In: 2019 IEEE Innovative Smart Grid Technologies - Asia (ISGT Asia); Chengdu, China; 2019. pp. 2837-2841.
- [118] Pourmousavi SA, Nehrir MH. Demand response for smart microgrid: initial results. In: ISGT 2011; Anaheim, CA, USA; 2011. pp. 1-6.
- [119] Hemapala KTMU, Kulasekera AL. Demand side management for microgrids through smart meters. In: Power and Energy Systems; Phuket, Thailand; 2012.
- [120] Hee-Jun Cha, Jin-Young Choi, Dong-Jun Won. Smart load management in demand response using microgrid ems. In: 2014 IEEE International Energy Conference (ENERGYCON); Cavtat, Croatia; 2014. pp. 833-837.
- [121] Zhang C, Xu Y, Dong ZY, Wong KP. Robust coordination of distributed generation and price-based demand response in microgrids. *IEEE Transactions on Smart Grid* 2018; 9 (5): 4236-4247. doi: 10.1109/TSG.2017.2653198
- [122] Acharya S, El-Moursi MS, Al-Hinai A, Al-Sumaiti AS, Zeineldin HH. A control strategy for voltage unbalance mitigation in an islanded microgrid considering demand side management capability. *IEEE Transactions on Smart Grid* 2019; 10 (3): 2558-2568. doi: 10.1109/TSG.2018.2804954
- [123] Yang X, Zhang Y, He H, Ren S, Weng G. Real-time demand side management for a microgrid considering uncertainties. *IEEE Transactions on Smart Grid* 2019; 10 (3): 3401-3414. doi: 10.1109/TSG.2018.2825388
- [124] Yang X, Zhang Y, Wu H, He H. An event-driven adr approach for residential energy resources in microgrids with uncertainties. *IEEE Transactions on Industrial Electronics* 2019; 66 (7): 5275-5288. doi: 10.1109/TIE.2018.2868019
- [125] Bhamidi L, Sivasubramani S. Optimal planning and operational strategy of a residential microgrid with demand side management. *IEEE Systems Journal* 2020; 14 (2): 2624-2632. doi: 10.1109/JSYST.2019.2918410
- [126] Li Z, Xu Y, Feng X, Wu Q. Optimal stochastic deployment of heterogeneous energy storage in a residential multienergy microgrid with demand-side management. *IEEE Transactions on Industrial Informatics* 2021; 17 (2): 991-1004. doi: 10.1109/TII.2020.2971227
- [127] Aderibole A, Zeineldin HH, Hosani MA, El-Saadany EF. Demand side management strategy for droop-based autonomous microgrids through voltage reduction. *IEEE Transactions on Energy Conversion* 2019; 34 (2): 878-888. doi: 10.1109/TEC.2018.2877750
- [128] Herath PU, Fusco V, Cáceres MN, Venayagamoorthy GK, Squartini S et al. Computational intelligence-based demand response management in a microgrid. *IEEE Transactions on Industry Applications* 2019; 55 (1): 732-740. doi: 10.1109/TIA.2018.2871390
- [129] Nazemi SD, Mahani K, Ghofrani A, Amini M, Kose BE et al. Techno-economic analysis and optimization of a microgrid considering demand-side management. In: 2020 IEEE Texas Power and Energy Conference (TPEC); College Station, TX, USA; 2020. pp. 1-6.
- [130] Abedini M, Moradi MH, Hosseinian SM. Optimal management of microgrids including renewable energy sources using gпсо-gm algorithm. *Renewable Energy* 2016; 90: 430-439. doi: 10.1016/j.renene.2016.01.014
- [131] Conti S, Nicolosi R, Rizzo SA, Zeineldin HH. Optimal dispatching of distributed generators and storage systems for mv islanded microgrids. *IEEE Transactions on Power Delivery* 2012; 27 (3): 1243-1251. doi: 10.1109/TPWRD.2012.2194514
- [132] Gazijahani FS, Hosseinzadeh H, Abadi AA, Salehi J. Optimal day ahead power scheduling of microgrids considering demand and generation uncertainties. In: 2017 Iranian Conference on Electrical Engineering (ICEE); Tehran; 2017. pp. 943-948.
- [133] Chaouachi A, Kamel RM, Andoulsi R, Nagasaka K. Multiobjective intelligent energy management for a microgrid. *IEEE Transactions on Industrial Electronics* 2013; 60 (4): 1688-1699. doi: 10.1109/TIE.2012.2188873
- [134] Arcos-Aviles D, Guinjoan F, Pascual J, Marroyo L, Sanchis P et al. A Review of Fuzzy-Based Residential Grid-Connected Microgrid Energy Management Strategies for Grid Power Profile Smoothing. In: Motoasca E, Agarwal AK, Breesch H (editors). Singapore: Springer, 2019, pp. 165-199.

- [135] Arcos-Aviles D, Pascual J, Marroyo L, Sanchis P, Guinjoan F. Fuzzy logic-based energy management system design for residential grid-connected microgrids. *IEEE Transactions on Smart Grid* 2018; 9 (2): 530-543. doi: 10.1109/TSG.2016.2555245
- [136] Arcos-Aviles D, Pascual J, Guinjoan F, Marroyo L, Sanchis P et al. Low complexity energy management strategy for grid profile smoothing of a residential grid-connected microgrid using generation and demand forecasting. *Applied Energy* 2017; 205: 69-84. doi: 10.1016/j.apenergy.2017.07.123
- [137] Pascual J, Barricarte J, Sanchis P, Marroyo L. Energy management strategy for a renewable-based residential microgrid with generation and demand forecasting. *Applied Energy* 2015; 158: 12-25. doi: 10.1016/j.apenergy.2015.08.040
- [138] Pascual J, Sanchis P, Marroyo L. Implementation and control of a residential electrothermal microgrid based on renewable energies, a hybrid storage system and demand side management. *Energies* 2014; 7 (1): 210-237. doi: 10.3390/en7010210
- [139] Dietrich K, Latorre JM, Olmos L, Ramos A. Demand response in an isolated system with high wind integration. *IEEE Transactions on Power Systems* 2012; 27 (1): 20-29. doi: 10.1109/TPWRS.2011.2159252
- [140] Pourmousavi SA, Nehrir MH, Sharma RK. Multi-timescale power management for islanded microgrids including storage and demand response. *IEEE Transactions on Smart Grid* 2015; 6 (3): 1185-1195. doi: 10.1109/TSG.2014.2387068
- [141] Tsikalakis AG, Hatziaargyriou ND. Centralized control for optimizing microgrids operation. In: 2011 IEEE Power and Energy Society General Meeting; Detroit, MI, USA; 2011. pp. 1-8.
- [142] Bui V, Hussain A, Kim H. A multiagent-based hierarchical energy management strategy for multi-microgrids considering adjustable power and demand response. *IEEE Transactions on Smart Grid* 2018; 9 (2): 1323-1333. doi: 10.1109/TSG.2016.2585671
- [143] Alharbi W, Bhattacharya K. Demand response and energy storage in mv islanded microgrids for high penetration of renewables. In: 2013 IEEE Electrical Power Energy Conference; Halifax, NS, Canada; 2013. pp. 1-6.
- [144] Çimen H, Çetinkaya N, Vasquez JC, Guerrero JM. A microgrid energy management system based on non-intrusive load monitoring via multitask learning. *IEEE Transactions on Smart Grid* 2021; 12 (2): 977-987. doi: 10.1109/TSG.2020.3027491
- [145] Tayab UB, Zia A, Yang F, Lu J, Kashif M. Short-term load forecasting for microgrid energy management system using hybrid hho-fnn model with best-basis stationary wavelet packet transform. *Energy* 2020; 203: 117857. doi: 10.1016/j.energy.2020.117857
- [146] Meng L, Sanseverino ER, Luna A, Dragicevic T, Vasquez JC, Guerrero JM. Microgrid supervisory controllers and energy management systems: a literature review. *Renewable and Sustainable Energy Reviews* 2016; 60: 1263-1273. doi: 10.1016/j.rser.2016.03.003
- [147] Zia MF, Elbouchikhi E, Benbouzid M. Microgrids energy management systems: a critical review on methods, solutions, and prospects. *Applied Energy* 2018; 222: 1033-1055. doi: 10.1016/j.apenergy.2018.04.103
- [148] Arcos-Aviles D, García-Gutierrez G, Guinjoan F, Ayala P, Ibarra A et al. Fuzzy-based power exchange management between grid-tied interconnected residential microgrids. In: 2020 IEEE ANDESCON; Quito, Ecuador; 2020. pp. 1-7.
- [149] Gamarra C, Guerrero JM. Computational optimization techniques applied to microgrids planning: a review. *Renewable and Sustainable Energy Reviews* 2015; 48: 413-424. doi: 10.1016/j.rser.2015.04.025
- [150] Peças Lopes JA, Polenz SA, Moreira CL, Cherkaoui R. Identification of control and management strategies for lv unbalanced microgrids with plugged-in electric vehicles. *Electric Power Systems Research* 2010; 80 (8): 898-906. doi: 10.1016/j.epsr.2009.12.013

- [151] López MA, Martín S, Aguado JA, De La Torre S. V2G strategies for congestion management in microgrids with high penetration of electric vehicles. *Electric Power Systems Research* 2013; 104: 28-34. doi: 10.1016/j.epsr.2013.06.005
- [152] Karfopoulos EL, Papadopoulos P, Skarvelis-Kazakos S, Grau I, Cipcigan LM et al. Introducing electric vehicles in the microgrids concept. In: 2011 16th International Conference on Intelligent System Applications to Power Systems; Hersonissos, Greece; 2011. pp. 1-6.
- [153] Shi W, Xie X, Chu C, Gadh R. Distributed optimal energy management in microgrids. *IEEE Transactions on Smart Grid* 2015; 6 (3): 1137-1146. doi: 10.1109/TSG.2014.2373150
- [154] López MA, Martín S, Aguado JA, De La Torre S. Optimal microgrid operation with electric vehicles. In: 2011 2nd IEEE PES International Conference and Exhibition on Innovative Smart Grid Technologies; Manchester, UK; 2011. pp. 1-8.
- [155] Farzin H, Ghorani R, Fotuhi-Firuzabad M, Moeini-Aghtaie M. A market mechanism to quantify emergency energy transactions value in a multi-microgrid system. *IEEE Transactions on Sustainable Energy* 2019; 10 (1): 426-437. doi: 10.1109/TSTE.2017.2741427
- [156] Dehghanpour K, Nehrir H. An agent-based hierarchical bargaining framework for power management of multiple cooperative microgrids. *IEEE Transactions on Smart Grid* 2019; 10 (1): 514-522. doi: 10.1109/TSG.2017.2746014
- [157] Utkarsh K, Srinivasan D, Trivedi A, Zhang W, Reindl T. Distributed model-predictive real-time optimal operation of a network of smart microgrids. *IEEE Transactions on Smart Grid* 2019; 10 (3): 2833-2845. doi: 10.1109/TSG.2018.2810897
- [158] Esfahani MM, Hariri A, Mohammed OA. A multiagent-based game-theoretic and optimization approach for market operation of multimicrogrid systems. *IEEE Transactions on Industrial Informatics* 2019; 15 (1): 280-292. doi: 10.1109/TII.2018.2808183
- [159] Liu Y, Li Y, Gooi HB, Jian Y, Xin H, Jiang X, et al. Distributed robust energy management of a multimicrogrid system in the real-time energy market. *IEEE Transactions on Sustainable Energy* 2019; 10 (1): 396-406. doi: 10.1109/TSTE.2017.2779827
- [160] He X, Yu J, Huang T, Li C. Distributed power management for dynamic economic dispatch in the multimicrogrids environment. *IEEE Transactions on Control Systems Technology* 2019; 27 (4): 1651-1658. doi: 10.1109/TCST.2018.2816902
- [161] Babazadeh M, Nobakhti A. Robust decomposition and structured control of an islanded multi-dg microgrid. *IEEE Transactions on Smart Grid* 2019; 10 (3): 2463-2474. doi: 10.1109/TSG.2018.2798617
- [162] Zhang W, Xu Y. Distributed optimal control for multiple microgrids in a distribution network. *IEEE Transactions on Smart Grid* 2019; 10 (4): 3765-3779. doi: 10.1109/TSG.2018.2834921
- [163] Zhao Z, Yang P, Wang Y, Xu Z, Guerrero JM. Dynamic characteristics analysis and stabilization of pv-based multiple microgrid clusters. *IEEE Transactions on Smart Grid* 2019; 10 (1): 805-818. doi: 10.1109/TSG.2017.2752640
- [164] Schneider KP, Radhakrishnan N, Tang Y, Tuffner FK, Liu C et al. Improving primary frequency response to support networked microgrid operations. *IEEE Transactions on Power Systems* 2019; 34 (1): 659-667. doi: 10.1109/TPWRS.2018.2859742
- [165] Ahmad J, Tahir M, Mazumder SK. Improved dynamic performance and hierarchical energy management of microgrids with energy routing. *IEEE Transactions on Industrial Informatics* 2019; 15 (6): 3218-3229. doi: 10.1109/TII.2018.2877739
- [166] Haddadian H, Noroozian R. Multi-microgrid-based operation of active distribution networks considering demand response programs. *IEEE Transactions on Sustainable Energy* 2019; 10 (4): 1804-1812. doi: 10.1109/TSTE.2018.2873206
- [167] Xu D, Zhou B, Chan KW, Li C, Wu Q et al. Distributed multienergy coordination of multimicrogrids with biogas-solar-wind renewables. *IEEE Transactions on Industrial Informatics* 2019; 15 (6): 3254-3266. doi: 10.1109/TII.2018.2877143

- [168] Hashempour MM, Lee T, Savaghebi M, Guerrero JM. Real-time supervisory control for power quality improvement of multi-area microgrids. *IEEE Systems Journal* 2019; 13 (1): 864-874. doi: 10.1109/JSYST.2018.2823899
- [169] Shuai Z, Peng Y, Liu X, Li Z, Guerrero JM, Shen ZJ. Dynamic equivalent modeling for multi-microgrid based on structure preservation method. *IEEE Transactions on Smart Grid* 2019; 10 (4): 3929-3942. doi: 10.1109/TSG.2018.2844107
- [170] Cheng Y, Wang J, Zhu F, Ding Z. Emission-aware microgrid cluster energy management scheme: a distributed trading approach. In: 2019 IEEE Industry Applications Society Annual Meeting; Baltimore, MD, USA; 2019. pp. 1-9.
- [171] Du Y, Li F. Intelligent multi-microgrid energy management based on deep neural network and model-free reinforcement learning. *IEEE Transactions on Smart Grid* 2020; 11 (2): 1066-1076. doi: 10.1109/TSG.2019.2930299
- [172] Dabbaghjamanesh M, Wang B, Mehraeen S, Zhang J, Kavousi-Fard A. Networked microgrid security and privacy enhancement by the blockchain-enabled internet of things approach. In: 2019 IEEE Green Technologies Conference (GreenTech); Lafayette, LA, USA; 2019. pp. 1-5.
- [173] Zhou L, Wu X, Xu Z, Fujita H. Emergency decision making for natural disasters: An overview. *International Journal of Disaster Risk Reduction* 2018; 27: 567-576. doi: 10.1016/j.ijdr.2017.09.037
- [174] Wu L, Ortmeier T, Li J. The community microgrid distribution system of the future. *The Electricity Journal* 2016; 29 (10): 16-21. doi: 10.1016/j.tej.2016.11.008
- [175] Davis G, Snyder AF, Mader J. The future of distribution system resiliency. In: 2014 Clemson University Power Systems Conference; Clemson, SC, USA; 2014. pp. 1-8.
- [176] Schneider KP, Tuffner FK, Elizondo MA, Liu C, Xu Y et al. Evaluating the feasibility to use microgrids as a resiliency resource. *IEEE Transactions on Smart Grid* 2017; 8 (2): 687-696. doi: 10.1109/TSG.2015.2494867
- [177] Xu Y, Liu C, Schneider KP, Ton DT. Toward a resilient distribution system. In: 2015 IEEE Power Energy Society General Meeting; Denver, CO, USA; 2015. pp. 1-5.
- [178] Abdubannaev J, YingYun S, Xin A, Makhmadjanova N, Rakhimov S. Investigate networked microgrids to enhance distribution network system resilience. In: 2020 IEEE/IAS Industrial and Commercial Power System Asia (I CPS Asia); Weihai, China; 2020. pp. 310-315.
- [179] Wang Y, Chen C, Wang J, Baldick R. Research on resilience of power systems under natural disasters—A review. *IEEE Transactions on Power Systems* 2016; 31 (2): 1604-1613. doi: 10.1109/TPWRS.2015.2429656
- [180] Wang Z, Wang J. Self-healing resilient distribution systems based on sectionalization into microgrids. *IEEE Transactions on Power Systems* 2015; 30 (6): 3139-3149. doi: 10.1109/TPWRS.2015.2389753
- [181] Poudel S, Dubey A. Critical load restoration using distributed energy resources for resilient power distribution system. *IEEE Transactions on Power Systems* 2019; 34 (1): 52-63. doi: 10.1109/TPWRS.2018.2860256
- [182] Sedzro KSA, Lamadrid AJ, Zuluaga LF. Allocation of resources using a microgrid formation approach for resilient electric grids. *IEEE Transactions on Power Systems* 2018; 33 (3): 2633-2643. doi: 10.1109/TPWRS.2017.2746622
- [183] Choobineh M, Mohagheghi S. Emergency electric service restoration in the aftermath of a natural disaster. In: 2015 IEEE Global Humanitarian Technology Conference (GHTC); Seattle, WA, USA; 2015. pp. 183-190.
- [184] Khederzadeh M, Zandi S. Enhancement of distribution system restoration capability in single/multiple faults by using microgrids as a resiliency resource. *IEEE Systems Journal* 2019; 13 (2): 1796-1803. doi: 10.1109/JSYST.2019.2890898
- [185] Yuan C, Illindala MS, Khalsa AS. Modified viterbi algorithm based distribution system restoration strategy for grid resiliency. *IEEE Transactions on Power Delivery* 2017; 32 (1): 310-319. doi: 10.1109/TPWRD.2016.2613935
- [186] Borghei M, Ghassemi M, Liu C. Optimal capacity and placement of microgrids for resiliency enhancement of distribution networks under extreme weather events. In: 2020 IEEE Power Energy Society Innovative Smart Grid Technologies Conference (ISGT); Washington, DC, USA; 2020. pp. 1-5.

- [187] Li J, Ma X, Liu C, Schneider KP. Distribution system restoration with microgrids using spanning tree search. *IEEE Transactions on Power Systems* 2014; 29 (6): 3021-3029. doi: 10.1109/TPWRS.2014.2312424
- [188] Gao H, Chen Y, Xu Y, Liu C. Resilience-oriented critical load restoration using microgrids in distribution systems. *IEEE Transactions on Smart Grid* 2016; 7 (6): 2837-2848. doi: 10.1109/TSG.2016.2550625
- [189] Zhu J, Gu W, Jiang P, Song S, Liu H et al. Dynamic island partition for distribution system with renewable energy to decrease customer interruption cost. *Journal of Electrical Engineering and Technology* 2017; 12 (6): 2146-2156. doi: 10.5370/JEET.2017.12.6.2146
- [190] Bajpai P, Chanda S, Srivastava AK. A novel metric to quantify and enable resilient distribution system using graph theory and choquet integral. *IEEE Transactions on Smart Grid* 2018; 9 (4): 2918-2929. doi: 10.1109/TSG.2016.2623818
- [191] Anuranj NJ, Mathew RK, Ashok S, Kumaravel S. Resiliency based power restoration in distribution systems using microgrids. In: 2016 IEEE 6th International Conference on Power Systems (ICPS); New Delhi, India; 2016. pp. 1-5.
- [192] Eskandarpour R, Lotfi H, Khodaei A. Optimal microgrid placement for enhancing power system resilience in response to weather events. In: 2016 North American Power Symposium (NAPS); Denver, CO, USA; 2016. pp. 1-6.
- [193] Zhu J, Yuan Y, Wang W. An exact microgrid formation model for load restoration in resilient distribution system. *International Journal of Electrical Power & Energy Systems* 2020; 116: 105568. doi: 10.1016/j.ijepes.2019.105568